

## INSTRUCTIONS FOR

0. GENERAL SAFETY INFORMATION, WARNINGS & CAUTIONS
1. INSTALLATION
2. THE USER
3. SERVICING
4. DISPOSAL

---

### MINIPACK MP SERIES PRESSURISATION UNITS WITH MICROPROCESSOR CONTROLS

MODELS: MP31, 32, 71, 72

---



ISSUE: 5 18/07/2017

---

Head Office: AGM House, London Rd, Copford, Colchester, Essex CO6 1GT UK  
Tel: 01206 215121 Email: [aftersales@agm-plc.co.uk](mailto:aftersales@agm-plc.co.uk)

Manchester Office : Unit 10, Wheel Forge Way, Ashburton Road West, Manchester. M17 1EH  
Tel: 0161 226 4727 Email: [aftersales@agm-plc.co.uk](mailto:aftersales@agm-plc.co.uk)

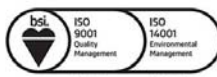

## PRODUCT IDENTIFICATION

All pressurisation units described in this manual automatically maintain a minimum set pressure, the “Cold Fill” pressure, in a heating or chilled system by transferring make-up liquid from a breaktank or sealed vessel into the system.  
 When the system pressure falls below the required level the Duty pump automatically refills the system until the pressure is restored. If the Duty Pump fails to maintain the required pressure the Support pump (where fitted) will operate in addition to the Duty Pump.

Please note that the Serial Number “WNxxxxx” or “SNxxxxx” and model reference will be visible on the unit’s label and on the back page of the manual supplied with the unit.

Examples of units manufactured by Aquatech Pressmain are shown below: -

Please note: it is also possible for the pump/controls/tanks to have been sold as a separate item, in which case the O&M manual and CE declaration may only be applicable in part.

Model number examples: -



MiniPack MPxx-B  
 Pressurisation unit with **B**asic controller



MiniPack MPxx-E  
 Pressurisation unit with **E**nhanced controller

MP		-		MiniPack MP
	3			max 3.0Bar cold fill pressure
	7			max 7.0Bar cold fill pressure
		1		1 pump
		2		2 pump
			B	Basic MPC controller
			E	Enhanced 2020+ controller

e.g. **MP31-B** = max 3.0Bar cold fill pressure with 1 pump and **B**asic MPC controller.





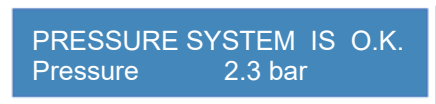

A “standard/basic” –B pressurisation unit controller has a 2 digit display: -



An “Enhanced” –E controller with BMS volt free relays has a 2 line by 20 or 24 character display: -



## CONTENTS

		<b>0.0 GENERAL SAFETY INFORMATION</b>		<b>4</b>
0.1		WARNINGS		5
0.2		CAUTIONS FOR INSTALLATION		5
0.3		CAUTIONS FOR OPERATION/USER		7
0.4		CAUTIONS FOR MAINTENANCE		7
<b>1.</b>		<b>INSTALLATION INSTRUCTIONS</b>		<b>8</b>
1.1		GENERAL		8
1.2		ADDITIONAL WARNINGS & CAUTIONS		8
1.3		PROCEDURE		8
1.3.1		LOCATION		8
1.3.2		FIXING		8
1.3.3		PIPEWORK		8
1.3.4		EXPANSION, CONTROL and HYDRAULIC ACCUMULATOR VESSELS		11
1.3.5		IDENTIFYING MiniPack "Standard/Basic" -B or "Enhanced" -E UNITS		12
1.3.6		ELECTRICAL		12
<b>2.</b>		<b>USER INSTRUCTIONS</b>		<b>14</b>
2.1		CUSTOMER ASSURANCE		14
2.2		COMMISSIONING		15
2.3		OPERATING INSTRUCTIONS		15
2.3.1		ADDITIONAL CAUTIONS		15
2.3.2		NORMAL OPERATION		15
2.3.3		STANDARD/BASIC "-B" CONTROLLER OPERATION		15
2.3.4		ENHANCED "-E" CONTROLLER OPERATION		16
2.3.5		STANDARD/BASIC CONTROLLER SYSTEM WARNINGS & ALARMS		18
2.3.6		ENHANCED CONTROLLER SYSTEM WARNINGS		18
2.3.7		ENHANCED CONTROLLER SYSTEM ALARMS		19
		REMOTE SIGNALS ON ENHANCED MODELS ONLY		20
		RESETTING PARAMETERS		20
		SERVICING REMINDER		20
2.4		MAINTENANCE INSTRUCTIONS		20
2.4.1		ADDITIONAL CAUTIONS		20
2.4.2		PROCEDURE		20
<b>3.</b>		<b>SERVICING</b>		<b>21</b>

3.1	MAINTENANCE AND CARE OF YOUR EQUIPMENT .....	21
3.2	LEGAL REQUIREMENTS.....	21
3.3	SERVICE CONTACTS .....	21
<b>4.</b>	<b>DISPOSAL .....</b>	<b>21</b>
	<b><u>EC DECLARATION OF CONFORMITY .....</u></b>	<b>22</b>
	<b>OPERATING PARAMETERS.....</b>	<b>22</b>



## 0.0 GENERAL SAFETY INFORMATION



- These instructions are intended for the installer/operator/user/maintenance of this equipment and must be kept with the equipment, for the life of the equipment and made available to all persons. Please read GENERAL SAFETY INFORMATION 0.0, WARNINGS 0.1 and CAUTIONS 0.2, 0.3 & 0.4 before doing anything else, and then follow them carefully.
- The unit must only be installed/operated/used/maintained by a competent person; *A competent person is someone who is technically competent and familiar with safety practices and the hazards involved.*
- Hydraulic Accumulators/Expansion Vessels installed as part of/in conjunction with this equipment, with Pressure x Volume above 250 Bar-litres, require regular formal inspection by a *competent person*. This is a Legal Requirement under the "Pressure Systems Safety Regulations" (PSSR) and the Owner/User should be made aware of their responsibility for this. (see section 3. Servicing).
- Failure to install/operate/use/maintain the equipment as recommended below could cause damage to the equipment anything subsequently connected to it, and invalidate the warranty provided by AquaTech-Pressmain to the buyer.
- Any damage caused to the equipment by misapplication, mishandling or misuse could lead to risk of **Electrocution, Burns, Fire, Flooding or injury to people or property** dependent upon the circumstances involved.
- This equipment contains moving/rotating parts that must remain guarded. Removal of or missing guards could lead to serious personal injury.
- This equipment automatically restarts after a power interruption.
- We accept no responsibility or liability for any consequences or damage/losses due to misapplication, mishandling or misuse of the equipment.
- It should be noted that the assembly of pressure equipment on site under the responsibility of the user (or his representative) is not subject to the Pressure Equipment Directive 97/23/EC. (National legislation covering assembly on site will apply)
- The latest version of this instruction manual with up to date safety information can be downloaded from our website at [www.aquatechpressmain.co.uk](http://www.aquatechpressmain.co.uk)



## 0.1 WARNINGS

- 0.1.1 Do not touch any live parts for at least 5 minutes after switching off the electricity supply. Failure to observe this will constitute a severe Electric shock and/or Burns hazard and may be lethal.
- 0.1.2 The equipment is only suitable for earth referenced supplies and must be permanently earthed to avoid Electric shock hazard.
- 0.1.3 With equipment isolator OFF, mains voltage may still be present from BMS system. This constitutes an Electric shock hazard.
- 0.1.4 Emergency stop button does not remove dangerous voltages from control panel/pump motor assemblies. This constitutes an Electric shock hazard.
- 0.1.5 Metal parts (e.g. heat sinks) may reach temperatures of 90 degrees centigrade and will constitute a Burns hazard.
- 0.1.6 Some equipment is designed to operate with liquid temperatures up to 150 degrees centigrade and will constitute a Burns/scalding hazard.
- 0.1.7 The equipment must not be pressurised beyond the maximum working pressure as stated on pumps/pipework/vessels/control panel otherwise serious mechanical damage/destruction could occur causing injury to people or property.
- 0.1.8 The equipment must not be heated/chilled beyond the maximum/minimum working temperature as stated on pumps/pipework/vessels/control panel otherwise serious mechanical damage/destruction could occur causing injury to people or property.
- 0.1.9 Any damage to equipment, pumpset, vessels, pipework or system components caused by misapplication, mishandling or misuse could lead to Electric shock hazard, Burns hazard, Fire hazard, Flooding hazard or cause injury to people or property.
- 0.1.10 This equipment may contain moving/rotating parts that must remain guarded. Removal of or missing guards could lead to serious personal injury.
- 0.1.11 Pressure vessels must never be disassembled whilst in use, they contain high pressure air/gas charge which could cause injury to people or property.
- 0.1.12 Pump motors with lifting eyes; the lifting eyes are only suitable for lifting motors NOT the entire pump assembly. This could cause injury to people or property.
- 0.1.13 Ensure the base/foundation/plinth/wall to which the equipment is to be attached is sufficiently strong enough to carry the entire mass of the equipment including the water that it will contain under worst-case fault conditions. E.g. fully saturated pressure vessel with no air charge, break tank full to overflowing, etc. Failure to observe this could cause serious mechanical damage/destruction resulting in injury to people or property.
- 0.1.14 This equipment contains a fluid which may under certain circumstances leak/drip/spray fluid (e.g. servicing, repair or malfunction). Ensure any fluid discharge will not cause damage to the surroundings by taking appropriate action. E.g. install in a place that will not be damaged by leakage or install in a bunded area with adequate drainage.



## 0.2 CAUTIONS FOR INSTALLATION

- 0.2.1 READ GENERAL SAFETY INFORMATION 0.0, WARNINGS 0.1 and CAUTIONS 0.2, 0.3 & 0.4
- 0.2.2 The unit should only be installed/operated by a competent person; *A competent person is someone who is technically competent and familiar with safety practices and the hazards involved.*
- 0.2.3 Do not lift the pumpset by pipework. Lift the pumpset by the container pallet using a pallet/forklift or crane by passing strops underneath the skid using a spreader bar. Failure to utilise these facilities will result in damage to the pumpset.
- 0.2.4 Store in a dry place to avoid damp conditions deteriorating the equipment.
- 0.2.5 Protect against dirt, damage and frost. It is absolutely essential that no foreign matter such as pipe thread swarf, welding slag, grit or stones are allowed to enter the set. Debris of this type can cause severe damage to the mechanical seals, diaphragms and impeller. Frost/freezing will damage pumps/pipework and control panel components.
- 0.2.6 The equipment is only suitable for installation in a clean, dust free indoor environment, with adequate protection from heat and frost, and sufficient ventilation to ensure cooling of the motors. Ambient air temperature should

- be between 5 and 40 degrees centigrade, non-condensating. Operation outside of these conditions could seriously damage the equipment.
- 0.2.7** If the equipment were to be stored or taken out of service for a period of time (e.g. 1 week or more), then we would recommend draining the equipment of all water/liquid (with due regard to any local regulations) to prevent frost damage to components. When restarting is required we would recommend commissioning by our authorised service agent.
- 0.2.8** Ensure the base/foundation/plinth/wall to which the equipment is to be attached has sufficient mass compared to the equipment, in order to avoid noise/vibration transmission. E.g. the mass of the base should be at least five times the mass of the equipment.
- 0.2.9** Ensure the electrical supply is the correct voltage, current, frequency and type for the equipment supplied and that suitable circuit protection equipment is installed in the supply. Incorrect electrical installation could be an electric shock/burns/fire hazard.
- 0.2.10** When accessing the control panel to make electrical connections adopt anti-static procedures e.g. wear anti-static earthed wristband, to avoid risk of damaging the controller.
- 0.2.11** All products that are packaged to include Pressure vessel(s)/Hydraulic Accumulator(s)/Expansion Vessel(s) are classed as "Assemblies" under the Pressure Equipment Directive (PED). Where units are despatched with "Loose" vessel(s) for assembly on site it is absolutely essential that they be installed as detailed in the instructions using the fittings provided where appropriate. Failure to observe this will nullify compliance with the PED and may present a safety hazard. Your warranty may also be affected.
- 0.2.12** Where Hydraulic Accumulator(s)/Expansion Vessel(s) are supplied as a loose item, they must be installed/connected correctly before operating the equipment, otherwise serious damage from over-pressure/pump overheating could occur.
- 0.2.13** Do not operate this equipment/pumpset prior to commissioning (section 2.2) This could cause irreparable damage to equipment/pumpset/pipework/system components.
- 0.2.14** Isolate the equipment/pumpset before pressure testing system. Excess pressure could irreparably damage the pressure transducer, pressure switches (where fitted) and the diaphragms of pressure vessel/hydraulic accumulators.
- 0.2.15** It is the installers' responsibility to ensure subsequent pipework etc can accept the pressures generated by the equipment/pumpset and to install an overpressure safety device into the system with due respect to the suction pressure present on the pumpset, the pump closed valve pressure stated on the pump, the maximum working pressure stated on any of the attached pressure vessels and any other device connected to the system e.g. boilers, calorifiers etc.
- 0.2.16** When chlorination of the system is carried out, ensure that any residual chlorine is removed by thorough flushing as detailed in the HSE approved code of practice L8, to avoid damaging the equipment/pumpset. The normal level of chlorination is up to 2 parts per million (ppm), but shock dosing for sterilization purposes, at 25-50 ppm for 24-48 hours is acceptable as long as all chlorine is removed once the process is complete. Chlorination beyond these limits could seriously damage pumpset components and WILL NOT be covered by the warranty.
- 0.2.17** The installer/user is responsible for the installation of the correct earthing and protection according to valid national and local standards. All operations must be carried out by a suitably qualified person.
- 0.2.18** The equipment is only suitable for earth referenced supplies and must be permanently earthed to avoid electric shock hazard.
- 0.2.19** The equipment must be permanently earthed with appropriate sized Earthing.
- 0.2.20** Equipment containing variable speed drives/motors has high earth leakage current >3.5mA and will require additional earth bonding whereby a single conductor of increased size or duplicate earth conductors must be provided.
- 0.2.21** Never perform high voltage resistance tests on control panels, variable speed drives/motors without first disconnecting the panel/drive/motor from the circuit being tested as this will damage the built in electronic components.
- 0.2.22** Metal parts (e.g. heat sinks) may reach temperatures of 90 degrees centigrade.
- 0.2.23** EMC - With respect to BS EN61000-3-2 this equipment is defined as 'professional equipment' and therefore the installer/user may need to seek permission from the supply utility to connect this equipment to the public low voltage mains supply.
- 0.2.24** Do not use the "Pressurisation unit" for filling the system pipework. These types of equipment are only suitable for topping up small losses/leaks in the system. A separate means of filling e.g. a quick fill loop (check with local water regulations first!) should be used instead, with the system connection valve to the equipment closed.
- 0.2.25** Where "Expansion vessels" are used on LTHW heating system pressurisation units, the temperature of the fluid returning to the vessels should not exceed 70 degrees Centigrade as this could damage the vessel diaphragm. Where the temperature exceeds 70C an intermediate cooling vessel should be fitted.
- 0.2.26** For MTHW and HTHW pressurisation units use a Nitrogen vessel suitable for the system conditions. Please contact AquaTech-Pressmain for further information.

- 0.2.27** Do not use the “Pressurisation unit” for dosing the system with chemicals. Only allow clean cold water into the break tank. Anything other than clean cold water could damage the pumps/pipework components.
- 0.2.28** Drain cocks/valves and air bleed screws must not be left open as this could cause flooding.



### 0.3 CAUTIONS FOR OPERATION/USER

- 0.3.1** READ GENERAL SAFETY INFORMATION 0.0, WARNINGS 0.1 and CAUTIONS 0.2, 0.3 & 0.4
- 0.3.2** The unit should only be operated/used by a competent person; *A competent person is someone who is technically competent and familiar with safety practices and the hazards involved.*
- 0.3.3** The Owner/User of this equipment has a Legal Responsibility to ensure that it is subject to regular formal inspections. See Section 3. Servicing, for details.
- 0.3.4** Where Hydraulic Accumulator(s)/Expansion Vessel(s) are supplied as a loose item, they must be installed/connected correctly before operating the equipment, otherwise serious damage from over-pressure could occur.
- 0.3.5** The set must not be run until commissioned by an authorised AquaTech-Pressmain agent, this could irreparably damage the pump set and/or system components/pipework connected to it.
- 0.3.6** The pumpset should be left switched ON with the pumps switched to AUTO for normal operation.
- 0.3.7** The pumpset should not be left in “Hand” operation for more than 1 minute. This could lead to severe damage of pumpset components and/or pipework system from over-pressure and/or overheating.
- 0.3.8** Ensure pumpset has an adequate water supply at all times to prevent dry running causing pump seal damage and water leakage.
- 0.3.9** Do no attempt to start pumps without liquid in volutes (pumps must be fully primed); mechanical seals must have a film of liquid between faces for proper operation and to prevent damage.
- 0.3.10** Portable telephones or other electro-magnetic equipment must not be used near the set to avoid corruption of program and unpredictable operation of unit.
- 0.3.11** For Pressurisation units utilising Nitrogen Vessels (generally HTHW units) ensure there is an adequate supply of Nitrogen at all times to avoid mis-operation of the equipment.



### 0.4 CAUTIONS FOR MAINTENANCE

- 0.4.1** READ GENERAL SAFETY INFORMATION 0.0, WARNINGS 0.1 and CAUTIONS 0.2, 0.3 & 0.4
- 0.4.2** The unit should only be operated/maintained by a competent person; *A competent person is someone who is technically competent and familiar with safety practices and the hazards involved.*
- 0.4.3** Where the set is fitted with Building Management Services (BMS) interconnections, notify the appropriate persons before switching OFF for maintenance or adjustments, to avoid unnecessary alarm conditions occurring. WARNING: With pumpset isolator OFF, mains voltage may still be present from BMS system. This constitutes an Electric shock hazard.
- 0.4.4** To prevent seizing, pumpsets must not be left unused for long periods (e.g. 1 week).
- 0.4.5** Do not vent air from air valves on vessels. These are for adjustment of pre-set cushion pressures. If wrongly adjusted this will lead to incorrect operation of the pumpset and possible damage to pumps, pipework and system components from overheating and over-pressure.
- 0.4.6** Switch OFF pumpset before accessing pumps and/or control panel.

# 1. INSTALLATION INSTRUCTIONS

## 1.1 GENERAL

These instructions are intended for the installer of this pressurisation unit. Please follow them carefully.

The unit should only be installed by a competent person; *A competent person is someone who is technically competent and familiar with safety practices and the hazards involved.*

It should be noted that the assembly of pressure equipment on site under the responsibility of the user (or his representative) is not subject to the Pressure Equipment Directive 97/23/EC. (National legislation covering assembly on site will apply).

Failure to install the equipment as recommended below could invalidate the warranty provided by AquaTech-Pressmain to the purchaser.

## 1.2 ADDITIONAL WARNINGS & CAUTIONS

1.2.1 READ GENERAL SAFETY INFORMATION 0.0, WARNINGS 0.1 and CAUTIONS 0.2, 0.3 & 0.4

## 1.3 PROCEDURE

### 1.3.1 LOCATION

The pressurisation unit should be connected to the underside of the return header on the suction side of the circulating pump, but not within any influences from the circulating pump, and for a heating system, at the point of lowest temperature i.e. before the boiler.

If the equipment is to be installed in an unheated room, ensure that there is adequate frost protection. On a heating system do not lag any expansion vessel or its connection to the system. This can result in damage occurring.

The location of the equipment should have adequate drainage, bunding or other appropriate measures to protect assets and the building fabric in the event of leakage or water spillage. Failure to provide such measures may result in water damage to property and assets.

Ensure that location for the equipment provides adequate clear space to accommodate unit with reasonable access to all parts; AquaTech-Pressmain recommend a minimum distance of 500mm. There must be sufficient room to:-

fully open control panel door & withdraw diaphragms from vessels,

**Should any of these location conditions not be satisfied AquaTech-Pressmain reserve the right to charge labour on any warranty work required on the pumpset.**

### 1.3.2 FIXING

Lugs are provided for wall fixing on the back of the panel (see fig. 1.1)

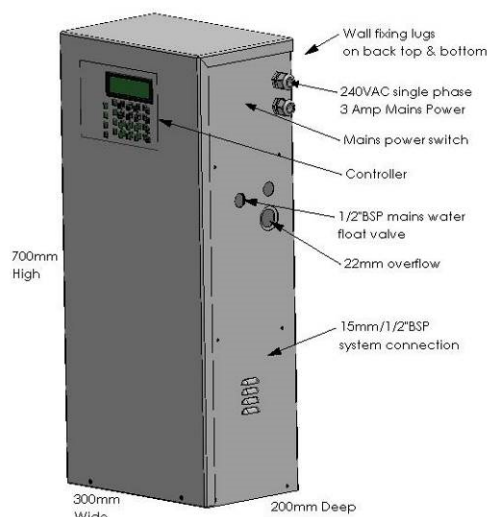

Fig 1.1

### 1.3.3 PIPEWORK



### 1.3.3.1 Mains Water Supply

- i. Fit an isolating valve in the supply to enable the unit to be isolated from the supply for maintenance. **Make sure the float valve restrictor is fitted if the mains water inlet pressure exceeds 1.5 Bar. If the mains water inlet pressure is less than 1.5 Bar, the restrictor should not be fitted.**
- ii. Float Valve Instructions as follows: -
- iii. For category 4 & 5 installations remove the filler tube to comply with local water regulations.

#### INSTALLATION INSTRUCTIONS (for component name reference, see diagram opposite)

- Before installation, ensure that the cistern is clean. Dirt or loose particles can affect the efficiency of the Hydroflo valve. Ensure that the supply water pipes are flushed through to remove any debris etc.
- Fit the float to the arm by screwing float threaded stem through arm.
- Assemble one of the back nuts on to the threaded tail of the main body with the raised shoulder facing away from the body. Fit the valve into the tank or cistern making sure the raised shoulder on the back nut is located in the cistern hole to centralise the valve. Fit the other back nut on the valve and tighten to secure. **DO NOT OVER TIGHTEN.** Make sure the float arm and float are free from obstruction.
- Adjust float position by rotating threaded stem so that the top of the float body is approx. 12mm below the water level marked on the inside of the cistern. The threaded stem may be shortened if it fouls the inside of the cistern lid.

#### IMPORTANT

Remove factory fitted flow restrictor if inlet pressure is below 25psi (1.5 bar or 50 ft head)

- Check that the overhead discharge nozzle assembly is securely fitted and that the filler tube is hanging vertically and is free from obstruction.
- Connect the water supply to the valve and turn on the water. Allow the cistern to fill and adjust the water level if necessary by moving the float. Observe that the arm moves freely up and down and that the valve is functioning correctly and shutting off when the required water level is achieved.

After shut off the valve may continue to drip from the hole in the pressure chamber cover. This is a necessary requirement of the valve design and may take a few minutes to stop.

Finally check carefully for leaks. Follow final checklist.

#### MAINTENANCE

The Hydroflo valve is fitted with a filter which may need cleaning occasionally to ensure that optimum water flow is maintained. The procedure for maintaining the valve is as follows:

- Turn off the water supply to valve. Unscrew the front nut and remove arm and pressure chamber cover. Remove diaphragm. Remove the filter extractor key from the overhead discharge nozzle assy. Insert the key through the centre of the support ring and seat, then rotate key until it locks behind the seat. Pull key - the support ring, seat and filter will become free from the main body. Remove filter from seat. Wash filter in clean water removing any debris that has been caught. Generally clean the inside of the valve body with clean water.

- Re-assemble in reverse order ensuring that the filter is pushed fully home in the seat. Make sure the monitoring pin in the diaphragm is free to move. Refit the pressure chamber assembly making sure the locating lug is positioned in the mating slot in the main body. Slide front nut over arm on to the main body and hand tighten. If the arm is removed for any reason, when refitting make sure that the small black seal is securely in place and that both location pegs are snapped into position.
- Turn on the water supply and ensure the valve operates correctly.
- Reset the float height to the required water level and follow final checklist.

#### FINAL CHECKLIST

1. Check all moving components operate freely and that the inlet valve shuts off correctly.
2. Check that all connections are tightened correctly.
3. Check carefully for leaks.
4. If water continues to flow from the overhead discharge nozzle assembly once filling of the cistern is complete, check that the front nut is fitted tightly. If loose, it should be secured at least hand tight (between 2 and 2.5 Newton metres). Do not over tighten.
5. If overflowing or poor filling subsequently occurs:
  - Check float and arm move up and down freely and that water level is correct.
  - Check that the filter is free from debris.
  - Check that the restrictor has been fitted in accordance with the instructions above.

#### WARNING!

No sealing compound, paste, flux or solvent to be used in contact with plastic or rubber surfaces, to avoid damage to plastic components. Rubber washers should provide adequate seal. PTFE tape may be used on threads. Do not over tighten plastic nuts.

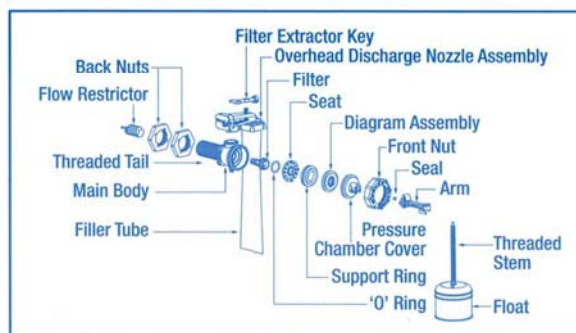

### 1.3.3.2 System Connection

- i. The unit must be connected with any expansion vessels and cooling vessels, to the underside of the return header on the suction side of the circulating pumps and boiler/chiller (see Location 1.3.1)
- ii. The system connection on the pressurisation unit is 15mm compression/1/2" BSP at the side of the cabinet. An isolating valve must be fitted to isolate the unit from the system.
- iv. All hydraulic accumulators and expansion vessels fitted to the system must have isolating and drain off valves to enable them to be serviced.
- v. All hydraulic accumulators and expansion vessels fitted to the system must have connecting pipework that is removable to give access for replacing vessel diaphragm, and must be large enough to avoid friction losses.
- vi. A quick filling device or other suitable means of filling the system, must be fitted to the system.

### 1.3.3.3 Overflow

- i. An overflow warning pipe is fitted to the side of the panel. This can be extended as required using 22mm OD pipe which will fit inside the supplied overflow.

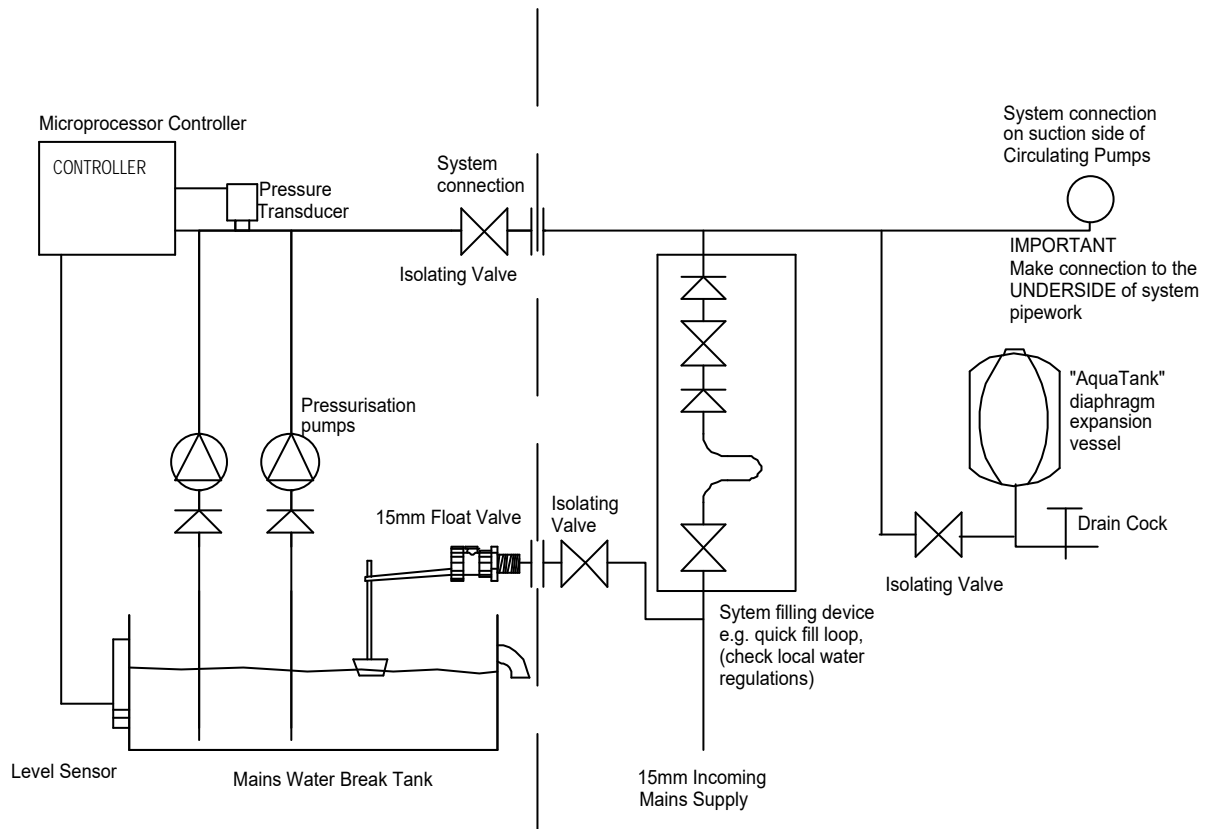

MiniPack Pressurisation Unit | Pipework supplied and fitted by installer

Fig 1.2: Typical Pipework Layout.

### 1.3.4 EXPANSION, CONTROL and HYDRAULIC ACCUMULATOR VESSELS



Fig 1.3 typical expansion vessel dimensions

Type (stockcode MTH-)	300060	300100	300200	300300	300500	700100	700200	700300	700500
Nominal Content –litres	60	100	200	300	500	100	200	300	500
D mm	409	480	634	634	740	450	485	485	600
H mm	740	840	980	1280	1485	850	1400	1965	2065
Water Connection DN BSP	1"	1"	1 ¼"	1 ¼"	1 ¼"	1"	1 ½"	1 ½"	1 ½"
Weight Kg	25	32	50	55	85	18	49	60	90
Max. working Pressure-bar	10	10	10	10	10	10	10	10	10
Max. Continuous temperature deg. C	70	70	70	70	70	100	100	100	100

All vessels must be securely mounted to prevent any movement from imposing strain on the attached pipework. Vessels of 60 litres capacity or greater **MUST** be mounted vertically on the integral legs with water connection lowermost. Set up the vessel so the air charge filling valve (top) and the diaphragm (bottom on 70°C vessels, top on 100°C vessels) are accessible for future maintenance. All vessels must have isolating and drain off valves fitted to enable them to be serviced. The connecting pipework should be removable to give access for replacing the diaphragm and should be the same size as the vessel connection to minimise friction losses. Note: if using a flexible hose it must be suitable for the temperature of the system.

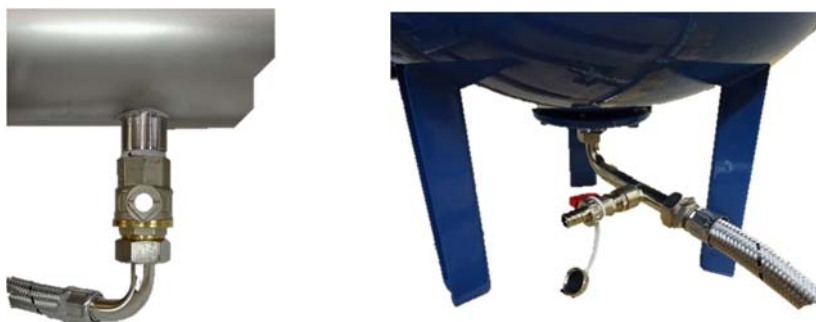

Fig. 1.4a & b Isolation valve on system pipework & Flexible hose with drain cock on vessel

Set the air cushion pre-charge pressure (see 2.4.2 Maintenance Procedure for details) to the correct level, dependent on the application required for the vessel. Refer to the Operating parameters at the back of this manual or Aquatech-Pressmain for advice.

Caution: If the air cushion pre-charge pressure required exceeds 4.0 Bar then you must follow the procedure shown in section 2.4 to avoid damaging/rupture of the internal diaphragm and consequences of. E.g. High and/or low pressure problems, unstable pump operation.

### 1.3.5 IDENTIFYING MiniPack “Standard/Basic” -B or “Enhanced” -E UNITS

1.3.5.1 The control panel fascia will state the “Model” and the “Serial Number” e.g. *WN12345* or *SN0654321*. In addition to this: -

1.3.5.2 A “standard/basic” –B pressurisation unit controller has a 2 digit display: -

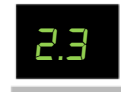

1.3.5.3 An “Enhanced” –E controller with BMS volt free relays has a 2 line by 20 or 24 character display: -

PRESSURE SYSTEM IS O.K.  
Pressure 2.3 bar

### 1.3.6 ELECTRICAL

READ GENERAL SAFETY INFORMATION 0.0, WARNINGS 0.1 and CAUTIONS 0.2, 0.3 & 0.4

- 1.3.6.1 All wiring must comply with the latest addition of local wiring Regulations.
- 1.3.6.2 **Wear anti-static wrist strap at all times** to avoid static discharge causing problems with the built in electronic program.
- 1.3.6.3 Connect incoming electrical mains supply to isolating switch & Earth stud in panel (see fig.1.6). Ensure voltages and frequency indicated on the motor nameplates and wiring diagrams correspond with supply mains data and that the supply fuse ratings are correct for the total current rating of the equipment. Refer to wiring diagram supplied with the unit or AquaTech-Pressmain.
- 1.3.6.4 For standard controller units: Connect boiler/chiller to plug/socket terminal on pcb card in series with the boiler/chiller control circuits so that in the event of a fault condition occurring the boiler/chillers shut down and remain inoperative until the fault condition is rectified. (See fig 1.6b). Boiler relay is energised for normal condition and releases to a high or low-pressure alarm fault condition.
- 1.3.6.5 For Enhanced controller units: Make any BMS connections required to terminals A-Z on Interface pcb card inside control panel. Connect boiler/chiller terminals nos. X,Y,Z on interface card in series with the boiler/chiller control circuits so that in the event of a fault condition occurring the boiler/chillers shut down and remain inoperative until the fault condition is rectified. (See fig 1.7). Boiler relay is energised for normal condition and releases to a high or low-pressure alarm fault condition.
- 1.3.6.5 Complete any required earth bonding.

Note: To aid access to the controls, switch off the power, remove outer cover, undo the two control shelf retaining screws (Fig 1.5a), the control shelf will now hinge forward (Fig 1.5b). When complete reverse the above sequence ensuring the two control shelf retaining screws are refitted correctly to ensure the keypad & display line up with the holes in the outer cover. **DO NOT** trap any wires!



Fig 1.5a Control shelf retaining screws.



Fig 1.5b Control shelf hinged down.

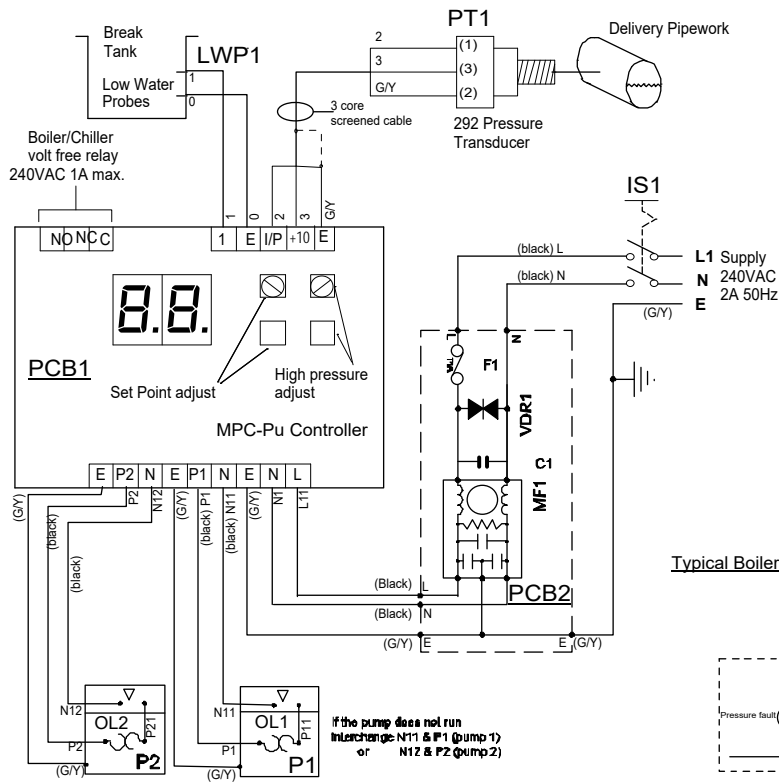

Fig 1.6a Typical standard -B controller Wiring Diagram

Typical Boiler Interrupt Circuit (wiring by others)

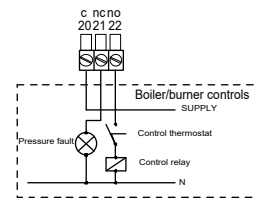
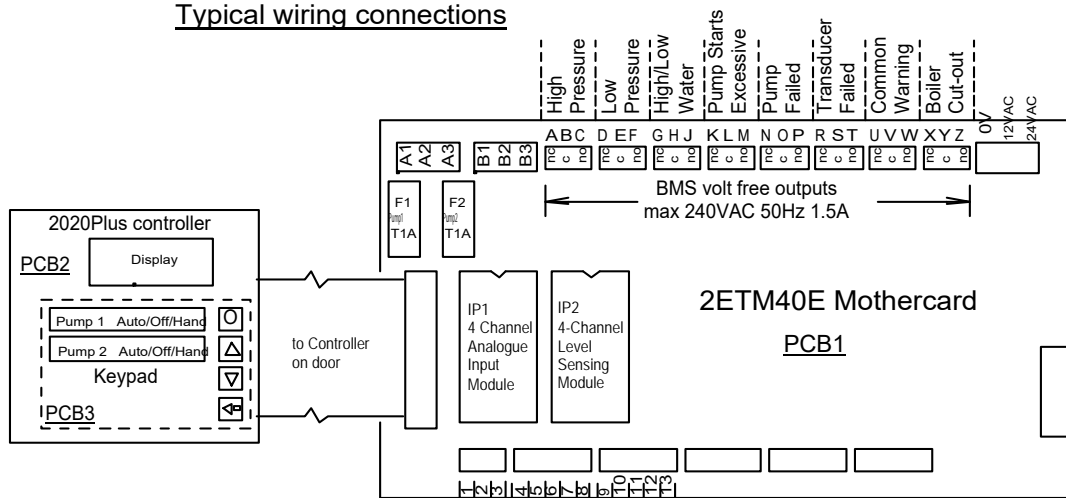

Fig 1.6b Typical Boiler wiring (by others)

Typical wiring connections



Typical Boiler Interrupt Circuit (wiring by others)

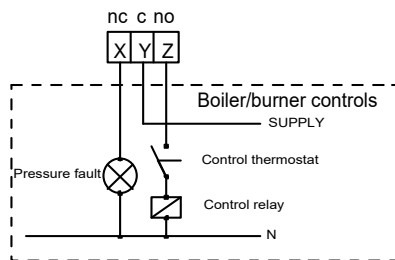

Fig 1.7 Typical Enhanced -E controller Wiring Diagram

---

## 2. USER INSTRUCTIONS

### 2.1 CUSTOMER ASSURANCE

**AQUATECH PRESSMAIN ASSURE YOU THAT IF ANY PART OF THIS EQUIPMENT BECOMES DEFECTIVE DUE TO FAULTY MANUFACTURE OR MATERIALS WITHIN 24 MONTHS FROM THE DATE OF INVOICE THE PART WILL BE REPAIRED OR REPLACED.**

The only conditions are: -

- ◆ The equipment must have been installed, commissioned, operated and maintained as recommended by **AquaTech-Pressmain**.
- ◆ The equipment must not have been neglected, misused, modified, or used for any other purpose than its original application.
- ◆ The commissioning should be carried out within 6 months of the date of invoice by an authorised **AquaTech-Pressmain** agent
- ◆ This Assurance does not apply to those items not supplied by us or to defects arising from parts not made or approved by **AquaTech-Pressmain**. The individual manufacturers own policies for dealing with defects will apply.
- ◆ Any part repaired or replaced under these Assurances will be covered for the balance of the appropriate Assurance period.
- ◆ If we have any disagreement about these Assurances which we are unable to resolve we will both abide by the decision of an agreed Arbitrator or, if we are unable to agree, one appointed by the Building and Engineering Services Association (B & ES) Arbitration Scheme Rules.
- ◆ These Assurances are in addition to, and do not detract from, the contractual rights you have under Statute or at common law.
- ◆ Failure to comply with the installation, commissioning and maintenance procedures will invalidate the warranty.

**For full details please see the AquaTech-Pressmain "CONDITIONS OF SALE"**

## 2.2 COMMISSIONING

Whilst this set has been tested in the factory to the required settings (detailed in operating parameters at the back of instruction manual), it is impossible to simulate the actual on-site conditions, especially if they are unusual. Also, the settings may have been disturbed since leaving the factory.

Therefore we strongly recommend **the set is commissioned by our authorised agent** who will prepare the set, make any necessary adjustments and leave the set in operational order.

Commissioning is a requirement to validate the Warranty (see Customer Assurance)

Prior to requesting an engineer to attend the site for commissioning, the client must ensure that;

- the equipment has been correctly installed;
- a written scheme of examination has been obtained where required under the Pressure Systems Safety Regulations;
- an adequate water supply and permanent electricity supply are available;
- the equipment and pipework in the building being served by the pressurisation unit is capable of accepting the generated pressures.

## 2.3 OPERATING INSTRUCTIONS

**This unit is used for maintaining the pressure in pressurised heating or chilled systems with a volume up to 10,000 litres at 82°C or boiler power up to 1000kW.**

READ GENERAL SAFETY INFORMATION 0.0, WARNINGS 0.1 and CAUTIONS 0.2, 0.3 & 0.4

### 2.3.1 ADDITIONAL CAUTIONS

**2.3.1.1 Isolate the pressurisation unit from the system before draining or modifying the system.** If the unit is drained it must be recommissioned.

### 2.3.2 NORMAL OPERATION

The pressurisation unit automatically maintains a minimum set pressure, the “Cold Fill” pressure, in a heating or chilled system by transferring make-up liquid from a breaktank or sealed vessel into the system. When the system pressure falls below the required level the Duty pump automatically refills the system until the pressure is restored. If the Duty Pump fails to maintain the required pressure the Support pump (where fitted) will operate in addition to the Duty Pump.

### 2.3.3 STANDARD/BASIC “-B” CONTROLLER OPERATION

The control is by AquaTech-Pressmain “MPC-Pu” Microprocessor, with a 2 character display on the control panel, showing the current system pressure in Bar.

To spread the wear evenly between the pumps the Duty Pump alternates each time both pumps stop (where two pumps are fitted).

If there is an interruption in the electrical supply the unit will restart on restoration of the supply.

**The unit must be left switched ON with the system connection valve OPEN.**

When switched on the display shows the controller type



Then self checks stating the firmware ref. eg.



Followed by the system pressure in bar  
(Screens shown are examples only)



### 2.3.4 ENHANCED “-E” CONTROLLER OPERATION

The control is by AquaTech-Pressmain “2020Plus” Microprocessor, with a 2-line by 20 or 24 character display on the control panel, showing the current system pressure and status.

When switched on the display shows, then self-checks, flashing all LED lights on keypad,

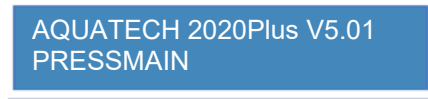

and identifies configuration for pump operation (e.g. “MP” pressurisation unit)



followed by the system status and pressure

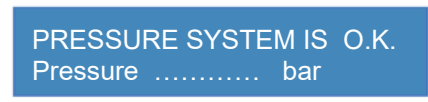

For “normal” operation, all Hand/Off/Auto switches should be left in “Auto”, all isolating valves should be left open, all hydraulic accumulator/expansion vessel isolating valves should be left open, and drain cock/valves should be left closed. Should it be necessary to have a situation that is not “normal” operation, then we would strongly recommend attendance to site by our trained/authorised service personnel. Please contact AquaTech-Pressmain for more details.

#### **Pump Operation**

##### **Sealed system pressurisation unit; All Models:**

The pressurisation unit automatically maintains a minimum set pressure, the “Cold Fill” pressure, in a heating or chilled system by transferring make-up liquid from a breaktank, into the system. When the system pressure falls below the required level the Duty pump automatically refills the system until the pressure is restored. If the Duty Pump fails to maintain the required pressure the Support pump (where fitted) will operate in addition to the Duty Pump.

**Duty Pump Rotation.** To spread the wear evenly across both pumps (where fitted), their sequence is automatically rotated either by starting the pump that has been idle the longest and/or by timed operation (dependent upon unit type). Indicator lights (where fitted) on the fascia show which pump is running.

##### **Automatic Restart (when “manual restart” is set to “not enabled” on 2020 Plus controller)**

If there is an interruption to the electrical supply the unit will automatically restart on restoration of the supply. Pumps will restart at timed intervals.

##### **Manual Restart (when set to “enabled” on 2020 Plus controller)**

If there is an interruption to the electrical supply, or there is a low water level condition, the unit will need to be manually reset on restoration of the supply, or low water level condition, by pressing the “Reset Alarm” key. Pumps will then restart at timed intervals.

**Pressure setting.** The pumpset is set at the default 'duty/cold fill' pressure at the factory. If necessary, the pressure will be adjusted at commissioning to suit local conditions.

#### **To view the parameters (Enhanced controller only)**

Press <SET/VIEW> on the keypad. Then, press the same key 4 more times.

Press the <UP> (7) key, to view the next parameter.

Page through the parameters by using the <UP> (7) and <DOWN> (8) keys to view:

Various parameters will be displayed dependent upon unit type. The main parameters that customers are interested in are shown on the following page.

Date and Time (24 hour clock)



not password protected to allow on site adjustment.

Fault Log (last 30 faults)



press <view> to see log followed by <up> (7) or <down> (8) to view log. press <enter> to return

Manual Restart upon power failure or low water level condition

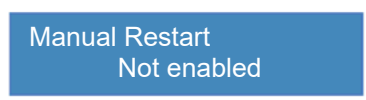

not password protected to allow user to enable/disable



Pumps 1 & 2 hours run time	Pump x run time 000123.4 Hours	
Time elapsed since last service	Since last service 000987.6 Hours	service reminder after 6 months
Total run time (power up time)	Total run time 005000.0 Hours	not resetable
Enable service call	Enable service call Enabled	enable/disable service reminder
Low pressure alarm	Low pressure 0.8 Bar	low pressure alarm. Note: low pressure approach warning is 0.2 bar more than this value
Low pressure delay	Low p delay 10 sec	time before alarm is initiated.
High pressure	High pressure 3.0 Bar	high pressure alarm. Note: high pressure approach warning is 0.2 bar below this value
High pressure delay	High p delay 10 sec	time before alarm is initiated.
Duty delay	Duty delay 0 sec	to delay duty pump starting to circulator pump pressure dips
Support delay	Support delay 10 sec	to delay support pump starting in normal operation preventing electrical/pressure dips/surges
Starts in 12 minutes	Starts/12 mns 8	sets frequency of pump starts warning (system leak detection)
Duty pressure (cold fill)	Duty pressure 1.6 bar	duty pump cut-out/cold fill pressure. All other pumps are derived from this value.
Minimum run time	Min run time 3 sec	for each pump

### 2.3.5 STANDARD/BASIC CONTROLLER SYSTEM WARNINGS & ALARMS

Flashing 2 digit display giving type of fault and a boiler/chiller volt free output signal for high or low pressure condition.

Relay energised for normal condition and releases for a high or low pressure alarm fault condition.

Displayed Message	Cause	Check
<b>LP</b> (Low pressure)	system pressure at/below low pressure setting & delay timer expired	Pressure vessel air charge wrong? Or water usage exceeds design capacity? Or pump(s) are tripped or air locked.
<b>LL</b> (Low water Level)	water level below supply tank low water alarm probe or pipework sensor dry. (240 second delay on automatic restart, after restoration of water level).	Break tank float valve stuck closed? Or output of pumpset exceeds mains water supply into break tank? Mains water interruption to break tank?
<b>HP</b> (High pressure)	system pressure at/above high pressure setting & delay timer expired	Pressure vessel air charge wrong? Or system water content exceeds design capacity? Or pump(s) are continuously running?.
<b>Or</b> (system pressure Over Range)	Pressure sensor output above 9.9 Bar or pressure sensor not connected correctly.	Pressure higher than 9.9 Bar? Or pressure sensor failed? Or pressure sensor wiring loose?
<b>SP</b> (setpoint point out of range)	The setpoint pressure has been set either below 1.2 Bar or above 9.9 Bar.	Adjust setpoint pressure within normal range.
No Display	1 Amp control fuse may have blown.	If unit has been switched off for a long period, a turbine pump (where fitted) may have seized. Switch off unit, insert flat blade screwdriver into slot on end of motor shaft and rotate pump until free. Replace fuse with T1Ax20mm, try again.

### 2.3.6 ENHANCED CONTROLLER SYSTEM WARNINGS

Flashing display giving type of fault and a various volt free output signals on BMS enhanced models. (see wiring diagram provided with unit to see which volt free signal relays are present. Typical example shown in fig. 1.7).

***** Warning *****	Cause	Check
High pressure approach	system pressure at high pressure setting minus 0.2 Bar	Pressure vessel air charge wrong? Or insufficient expansion capacity?
Low pressure approach	system pressure at low pressure setting plus 0.2 Bar	Pressure vessel air charge wrong? Or water usage exceeds design capacity?
Pump starts exceeded/is system leaking?	duty pump starts exceeded "starts in 12 mins" parameter	System pipework is leaking excessively? Starts parameter set too low?
Excessive run time/ is system leaking?	duty pump continuously running for 12 minutes	System pipework is leaking excessively?
Commissioning needed	Unit has not been commissioned by authorised service engineer	Have unit commissioned by authorised service engineer.
Power Up	Power interruption started "Power Up" sequence	Incoming electrical supply interruption? Or missing phase? Or loose connections?
Low level delay	A low water level condition has reset, and a 4 minute delay is now initiated before normal operation will resume	Check pumps are vented and wait for the delay time to expire
Manual restart (when set to enabled)	A power interruption or low water level has occurred,	Carry out all necessary checks, then press the "Reset alarm" key on the micro

### 2.3.7 ENHANCED CONTROLLER SYSTEM ALARMS

Flashing display giving type of fault, audible alarm, volt-free output signals on BMS Enhanced models, and action as described. (see below). (see wiring diagram provided with unit to see which volt free signal relays are present. Typical example shown in fig. 1.7).

**RESET:** Alarms are manually muted and reset using the UP (7) or DOWN (8) buttons on the keypad. (Automatic reset facility can be provided)

**** Alarm ****	Cause	Check
Pressure system Fault	Check pumps 1 & 2 for a pump-tripped condition.	Check electrical supply is within tolerance, or missing phase? Pump seized? motor failed? Motor thermistor overheated?
High pressure	system pressure at/above high pressure setting & delay timer expired	Pressure vessel air charge wrong? Or insufficient expansion capacity? Pump(s) left in Hand?
Low pressure	system pressure at/below low pressure setting & delay timer expired	Pressure vessel air charge wrong? Or water usage exceeds design capacity? Pump(s) switched Off or Tripped?
Transducer failed	Pressure sensor output above normal range of pressure sensor or pressure sensor not connected correctly.	Pressure higher than sensor range? Or pressure sensor failed? Or pressure sensor wiring loose?
Pump overload fault	Pump/Inverter tripped signal present	Check electrical supply is within tolerance, or missing phase? Pump seized? motor failed? Motor thermistor overheated?
No water in feed tank	water level below supply tank low water alarm probe or pipework sensor dry. (240 second delay on automatic restart, after restoration of water level).	Break tank float valve stuck closed? Or output of pumpset exceeds mains water supply into break tank? Mains water interruption to break tank?
Pump overheated	Pump motor temperature too high.	Pump seized? motor failed? Motor thermistor overheated?
High water level Tank 1	water level above supply tank high water alarm probe	Break tank float valve wrongly adjusted, stuck open or letting by? HP restrictor fitted to F/valve?
Low water level Tank 1	water level below supply tank low water alarm probe or pipework sensor dry. (240 second delay on automatic restart, after restoration of water level).	Break tank float valve stuck closed? Or output of pumpset exceeds mains water supply into break tank? Mains water interruption to break tank?
Other Fault	Hardware shutdown	Please call AquaTech-Pressmain for advice
No Display	1 Amp control fuse may have blown.	If unit has been switched off for a long period, a turbine pump (where fitted) may have seized. Switch off unit, insert flat blade screwdriver into slot on end of motor shaft and rotate pump until free. Replace fuse with T1Ax20mm, try again.

If a problem persists contact AQUATECH-PRESSMAIN quoting the serial number WN: \_\_\_\_\_ or SN: \_\_\_\_\_ (on control panel fascia)

## REMOTE SIGNALS on Enhanced models only

- volt free contacts in control panel (see fig 1.7) :

High system pressure, Low system pressure, High/Low Water level in break-tank, Excessive pump starts, Pump tripped/failed, Transducer failed, Common warning, , Boiler/chiller cut-out

## RESETTING PARAMETERS

The parameters can be protected from inadvertent alteration by a password security code. The factory default is for no password protection to be enabled. This can be changed to password protected if required. Parameters may be reset on site by a user or an Aquatech-Pressmain Service engineer.

## SERVICING REMINDER

When routine service is due display gives telephone no. to call  
This can be deactivated if required.

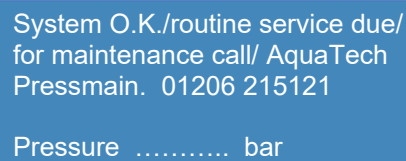

System O.K./routine service due/  
for maintenance call/ AquaTech  
Pressmain. 01206 215121  
  
Pressure ..... bar

If a problem persists contact **AQUATECH-PRESSMAIN** service department quoting the serial number **WN: \_\_\_\_\_** (on control panel fascia)

## 2.4 MAINTENANCE INSTRUCTIONS

### 2.4.1. ADDITIONAL CAUTIONS

2.4.1.1. READ GENERAL SAFETY INFORMATION 0.0, WARNINGS 0.1 and CAUTIONS 0.2, 0.3 & 0.4

### 2.4.2 PROCEDURE

Every 6 months the unit should be maintained by authorised AquaTech-Pressmain service agents - see Servicing (Section 3).

#### Expansion, Control and Hydro Accumulator vessels

1. **Air Charge Pressure.** The correct charge pressure provides reliable operation of the system and a prolonged lifetime of the diaphragm. This should be checked regularly. Caution: If the air cushion pre-charge pressure required exceeds 4.0 Bar then you must follow the procedure shown below to avoid damaging/rupture of the internal diaphragm and consequences of. E.g. High and/or low pressure problems, unstable pump operation.
2. **To adjust air charge pressure < 4.0Bar:** isolate the vessel from the system and release pressure on water side by opening the drain cock disposing of the water-mix in the appropriate manner. The water inside the bladder will be pushed back by the air charge pressure. Remove cap on the filling valve, set air charge pressure refilling using dry air or nitrogen. Screw cap firmly on filling valve. Close the drain cock and slowly open water connection to the system.
3. **To adjust air charge pressure > 4.0Bar:** If vessel is already in use then isolate hydraulically, reduce the air charge to 4.0Bar then evacuate the water side of the vessel followed by evacuation of the air side. With the vessel empty of water and air, set the air charge pressure (using dry air or nitrogen) to 4.0Bar, bring the water side pressure up to 5.0Bar and close isolating valve, then add more air until the air side pressure is equal to the required pre-charge pressure multiplied by 1.2 e.g. for a pre-charge pressure of 6.0Bar after filling vessel with air to 4.0Bar followed by water to 5.0Bar, fill the air side to  $6.0 \times 1.2 = 7.2\text{Bar}$ . Screw cap firmly on filling valve and slowly open isolating valve & water connection to the system.
4. **Float Valve Maintenance.** See installation instructions section for extract regarding cleaning float valve filter etc.

**LEAVE SET WITH ALL PUMPS SWITCHES IN THE AUTO POSITION,  
THE MAINS SUPPLY SWITCHED ON, AND THE SYSTEM CONNECTION OPEN**

## 3. SERVICING

### 3.1 MAINTENANCE AND CARE OF YOUR EQUIPMENT

The AquaTech-Pressmain equipment that is described in this instruction booklet has been manufactured and tested to the highest standards of design and quality. It will give trouble free operation over many years provided it is maintained regularly from when it is commissioned. To keep it operating efficiently in a safe, economical and environmentally friendly condition, regular maintenance is an essential part.

AquaTech-Pressmain along with its' service division, Acorn Pressurisation Services are the official providers of commissioning and maintenance services. (see below).

Several companies operating under the Aquatronic Group Management structure are available to fulfil a wide range of servicing and maintenance requirements, as detailed below.

### 3.2 LEGAL REQUIREMENTS

Hydraulic Accumulators/Expansion Vessels installed as part of/in conjunction with this equipment, with Pressure x Volume above 250 Bar-litres, require formal inspection in accordance with a "Written Scheme of Examination". This is a Legal Requirement on the part of the Owner/User under the "Pressure Systems Safety Regulations" (PSSR). A "Written Scheme" and regular inspection can be provided by either Acorn Pressurisation Services (combined maintenance and inspection) or ESIS Ltd (inspection only), see details below.

#### Plant Servicing & Inspection



**ACORN PRESSURISATION SERVICES,**

**AGM House, Essex, CO6 1GT.**

**Ph: 01206 215151**

**10 Wheel Forge Way, Manchester. M17 1EH. Ph: 0161 226 4727**

Acorn provides maintenance and installation of all types of packaged water pumping equipment for building services. Its specialist fields are Pressure booster equipment and sealed systems for heating and chilled water distribution systems.

Regular servicing of any plant for essential services is vital because wear and tear are very gradual processes.

With preventative maintenance, the costs are small and benefits in reliability, safety and economy can be significant. Acorn Pressurisation Services can provide a complete package of schemes for preventative maintenance on all AquaTech-Pressmain and other makes of equipment.

#### Pressure Vessel Inspection



**ESIS ENGINEERING SAFETY & INSPECTION SERVICES LTD,**

**AGM House, London Rd, Copford, Colchester, Essex, CO6 1GT.**

**Phone: 01206 215141**

Under the Pressure Systems Safety Regulations, expansion vessels and hydraulic accumulators, generally 250 bar-litres and greater, and protection devices, require a Written Scheme of Examination before they can be operated. ESIS Inspection and Insurance Services Limited specifications can provide the means to comply with these regulations. These services can be extended to cover other units e.g. air pressure receivers etc.

### 3.3 SERVICE CONTACTS

**For service during warranty period contact: AQUATECH-PRESSMAIN Service Department**

**Head Office Tel: 01206 215121**

**Manchester Office Tel: 0161 226 4727**

**For regular servicing, contact service division: ACORN PRESSURISATION SERVICES**

**Head Office Tel: 01206 215151**

**Manchester Office Tel: 0161 226 4727**

who will be pleased to give you expert advice on this or any other servicing matter.

## 5. DISPOSAL

Disposal of this product or parts of it must be carried out in accordance with the following guidelines:

Use the local public or private recycling/waste collection service.

In case such a recycling/waste collection service does not exist or cannot handle the materials used in this product, please deliver the product or any hazardous material from it to your nearest AquaTech-Pressmain office.

### EU Declaration of Conformity

We, Aquatronic Group Management Plc, declare that the equipment detailed below:  
**PRESSURISATION UNIT MODEL : MiniPack MP**  
 (according to drawing A12290)

Complies with the requirements of the following European Directives:  
**Pressure Equipment Directive 2014/68/EU (PED)**  
**Machinery Directive 2006/42/EC**  
**Low Voltage Directive 2014/35/EC**  
**Electro Magnetic Compatibility Directive 2014/30/EC**

**PED Conformity Assessment Modules**  
**Module B : Certificate No. CE 641230**  
**Module D : Certificate No. CE 641231**

**Notified Body : BSI, Kitemark Court, Knowlhill, Milton Keynes, MK5 8PP**  
**Notified Body No. 0086**



13/4/17

I.D.Taylor, I.Eng. MIET, Director,  
 Aquatronic Group Management T/A AquaTech-Pressmain  
 AGM House, London Rd, Copford, Colchester, Essex CO6 1GT UK  
 Telephone: 01206 215121

## OPERATING PARAMETERS

**SERIAL No.** ..... **MODEL MP** .....

THE SERIAL & MODEL NUMBERS MUST BE QUOTED WHEN REQUESTING ASSISTANCE

**ELECTRICAL DATA:**

Supply	240	volts	1	Ph	50	Hz
Full load current of pumpset	3	Amps				
Max. unit loading:	0.25	Kw	Method of starting:	DOL		

**NOISE LEVEL:** less than 70 db(A) unless otherwise stated .....

**PRESSURE SETTINGS:**

**AS FACTORY SET (MP3x/MP7x)**

	bar	[ENHANCED CONTROLLER ONLY]	secs
Duty pressure/Cold fill	1.2/4.0		
(Support pump cut-in)	(0.8)	[Support pump delay	6]
High Pressure	2.5/6.0	[High pressure delay	10]
Low pressure	0.6/3.2	[Low pressure delay	10]
Expansion vessel cushion pressure.	1.2/3.8		

❖ AMENDED AT COMMISSIONING	
bar	secs
.....	
.....	.....
.....	.....
.....	.....
.....	.....

❖ On commissioning it may be found necessary to modify these settings. Providing this information is left with the equipment, the figures will be updated by the commissioning engineer.  
 Updated by commissioning engineer ..... Date .....