

## INSTRUCTIONS FOR

0. GENERAL SAFETY INFORMATION, WARNINGS & CAUTIONS
1. INSTALLATION
2. THE USER
3. SERVICING
4. DISPOSAL

---

# MICROMATIC HM2AV, AQUAMATIC AMV-FB-E-SPEED

## SERIES COLD WATER PRESSURE BOOSTER SETS

MODELS: HM2AV, AMV-FB-E-SPEED

---



ISSUE 3 20/03/2019

---

Head Office: AGM House, London Rd, Copford, Colchester, Essex CO6 1GT UK  
Tel: 01206 215121 Email: [aftersales@agm-plc.co.uk](mailto:aftersales@agm-plc.co.uk)



PED (Pressure Equipment Directive) Compliant  
BSI Certificates CE 641230 & 641231



# PRODUCT IDENTIFICATION

All units described in this manual are used to automatically increase and maintain the water supply pressure to a preset 'Duty' pressure.

Please note that the Serial Number "SO:xxxxx" and model reference will be visible on a label on or near the control panel/consumer unit and on the back page of the manual supplied with the unit.

Examples of units manufactured by Aquatech Pressmain are shown below: -

Please note: it is also possible for the components to have been sold as separate items, in which case the O&M manual and CE declaration may only be applicable in part.



MicroMatic: HM2AV twin pump end suction Variable speed booster set with Flow Through Vessel & E-SPEED Motor Control



AquaMatic AMV2-FB-E-SPEED: twin pump vertical multistage Variable speed booster set with Flow Through Vessel & E-SPEED Motor Control







Model number examples: -

AMV	2	F	B	-	3-5	Cold water pressure booster set series
AMV						All Variable speed vertical multistage pumps
HM						HM twin pump variable speed, end suction pumpset
	2to4					Number of pumps (HM only available with 2 pumps)
		F				Flow Through vessel
		A				All End Suction pumps
			B			Basic E-SPEED Motor control
			V			Variable Speed
					3-5	Pump series

e.g. AMV2-FB-3-5- E-SPEED = 2 variable speed, vertical multistage pumps series 3-5, with flow through vessel and E-SPEED Motor control.

HM2AV-5-5 = 2 variable speed, horizontal end suction pumps series 5-5, with flow through vessel and E-SPEED Motor control.

# CONTENTS

	<b>0. GENERAL SAFETY INFORMATION</b>		<b>4</b>
0.1	 WARNINGS		5
0.2	 CAUTIONS FOR INSTALLATION		5
0.3	 CAUTIONS FOR OPERATION/USER		7
0.4	 CAUTIONS FOR MAINTENANCE		8
<b>1.</b>	<b>INSTALLATION INSTRUCTIONS</b>		<b>9</b>
1.1	ADDITIONAL WARNINGS		9
1.2	ADDITIONAL CAUTIONS		9
1.3	PROCEDURE		9
1.3.1	OFF-LOADING AT SITE		9
1.3.2	LOCATION		9
1.3.3	FIXING		9
1.3.4	PIPEWORK		10
1.3.5	FLOW THROUGH VESSELS		11
1.3.6	ELECTRICAL		12
1.3.7	GUIDANCE ON SELECTING THE CORRECT EARTH LEAKAGE PROTECTION DEVICE FOR BOOSTER SETS		13
<b>2.</b>	<b>USER INSTRUCTIONS</b>		<b>14</b>
2.1	CUSTOMER ASSURANCE		14
2.2	COMMISSIONING		14
2.3	OPERATING INSTRUCTIONS		15
2.3.1	ADDITIONAL WARNINGS		15
2.3.2	ADDITIONAL CAUTIONS		15
2.3.3	NORMAL OPERATION		15
2.3.4	MENU		16
2.3.5	WARNINGS		17
2.3.6	ALARMS		18
2.3.7	COMMON FAULTS		20
	VENTING PUMPS		20
2.3.8	REMOTE SIGNALS		20
2.4	MAINTENANCE INSTRUCTIONS		21
2.4.1	ADDITIONAL CAUTIONS		21

2.4.2 PROCEDURE.....	21
<b>3. SERVICING .....</b>	<b>22</b>
3.1 MAINTENANCE AND CARE OF YOUR EQUIPMENT .....	22
3.2 LEGAL REQUIREMENTS.....	22
3.3 SERVICE CONTACTS.....	22
<b>4. DISPOSAL.....</b>	<b>23</b>
<b>EU DECLARATION OF CONFORMITY .....</b>	<b>23</b>
<b>OPERATING PARAMETERS.....</b>	<b>24</b>



## 0. GENERAL SAFETY INFORMATION



- These instructions are intended for the installer/operator/user/maintenance of this equipment and must be kept with the equipment, for the life of the equipment and made available to all persons. Please read GENERAL SAFETY INFORMATION 0.0, WARNINGS 0.1 and CAUTIONS 0.2, 0.3 & 0.4 before doing anything else, and then follow them carefully.
- The unit must only be installed/operated/used/maintained by a competent person; A *competent person is someone who is technically competent and familiar with safety practices and the hazards involved.*
- Hydraulic Accumulators/Expansion Vessels installed as part of/in conjunction with this equipment, with Pressure x Volume above 250 Bar-litres, require regular formal inspection by a *competent person*. This is a Legal Requirement under the “Pressure Systems Safety Regulations” (PSSR) and the Owner/User should be made aware of their responsibility for this. (see section 3. Servicing).
- Failure to install/operate/use/maintain the equipment as recommended below could cause damage to the equipment any anything subsequently connected to it, and invalidate the warranty provided by AquaTech-Pressmain to the buyer.
- Any damage caused to the equipment by misapplication, mishandling or misuse could lead to risk of **Electrocution, Burns, Fire, Flooding or injury to people or property** dependent upon the circumstances involved.
- This equipment contains moving/rotating parts that must remain guarded. Removal of or missing guards could lead to serious personal injury.
- This equipment automatically restarts after a power interruption.
- We accept no responsibility or liability for any consequences or damage/losses due to misapplication, mishandling or misuse of the equipment.
- It should be noted that the assembly of pressure equipment on site under the responsibility of the user (or his representative) is not subject to the Pressure Equipment Directive 97/23/EC. (National legislation covering assembly on site will apply)
- The latest version of this instruction manual with up to date safety information can be downloaded from our website at [www.aquatechpressmain.co.uk](http://www.aquatechpressmain.co.uk)



## 0.1 WARNINGS

- 0.1.1 Do not touch any live parts for at least 5 minutes after switching off the electricity supply. Failure to observe this will constitute a severe Electric shock and/or Burns hazard and may be lethal.
- 0.1.2 The equipment is only suitable for earth referenced supplies and must be permanently earthed to avoid Electric shock hazard.
- 0.1.3 With equipment isolator OFF, mains voltage may still be present from BMS system. This constitutes an Electric shock hazard.
- 0.1.4 Emergency stop button does not remove dangerous voltages from control panel/pump motor assemblies. This constitutes an Electric shock hazard.
- 0.1.5 Power must not be interrupted to the unit more than 4 times per hour otherwise damage could occur to the inverter motors.
- 0.1.6 Metal parts (e.g. heat sinks) may reach temperatures of 90 degrees centigrade and will constitute a Burns hazard.
- 0.1.7 Some equipment is designed to operate with liquid temperatures up to 150 degrees centigrade and will constitute a Burns/scalding hazard.
- 0.1.8 The equipment must not be pressurised beyond the maximum working pressure as stated on pumps/pipework/vessels/control panel otherwise serious mechanical damage/destruction could occur causing injury to people or property.
- 0.1.9 The equipment must not be heated/chilled beyond the maximum/minimum working temperature as stated on pumps/pipework/vessels/control panel otherwise serious mechanical damage/destruction could occur causing injury to people or property.
- 0.1.10 Any damage to equipment, pumpset, vessels, pipework or system components caused by misapplication, mishandling or misuse could lead to Electric shock hazard, Burns hazard, Fire hazard, Flooding hazard or cause injury to people or property.
- 0.1.11 This equipment may contain moving/rotating parts that must remain guarded. Removal of or missing guards could lead to serious personal injury.
- 0.1.12 Pressure vessels must never be disassembled whilst in use, they contain high pressure air/gas charge which could cause injury to people or property.
- 0.1.13 Pump motors with lifting eyes; the lifting eyes are only suitable for lifting motors NOT the entire pump assembly. This could cause injury to people or property.
- 0.1.14 Ensure the base/foundation/plinth/wall to which the equipment is to be attached is sufficiently strong enough to carry the entire mass of the equipment including the water that it will contain under worst-case fault conditions. E.g. fully saturated pressure vessel with no air charge, break tank full to overflowing, etc. Failure to observe this could cause serious mechanical damage/destruction resulting in injury to people or property.
- 0.1.15 This equipment contains a fluid which may under certain circumstances leak/drip/spray fluid (e.g. servicing, repair or malfunction). Ensure any fluid discharge will not cause damage to the surroundings by taking appropriate action. E.g. install in a place that will not be damaged by leakage or install in a bunded area with adequate drainage.



## 0.2 CAUTIONS FOR INSTALLATION

- 0.2.1 READ GENERAL SAFETY INFORMATION 0.0, WARNINGS 0.1 and CAUTIONS 0.2, 0.3 & 0.4
- 0.2.2 The unit should only be installed/operated by a competent person; *A competent person is someone who is technically competent and familiar with safety practices and the hazards involved.*

- 
- 0.2.3** Do not lift the pumpset by pipework. Lift the pumpset by the container pallet using a pallet/forklift or crane by passing strops underneath the skid using a spreader bar. Failure to utilise these facilities will result in damage to the pumpset.
  - 0.2.4** Store in a dry place to avoid damp conditions deteriorating the equipment.
  - 0.2.5** Protect against dirt, damage and frost. It is absolutely essential that no foreign matter such as pipe thread swarf, welding slag, grit or stones are allowed to enter the set. Debris of this type can cause severe damage to the mechanical seals, diaphragms and impeller. Frost/freezing will damage pumps/pipework and control panel components.
  - 0.2.6** The equipment is only suitable for installation in a clean, dust free indoor environment, with adequate protection from heat and frost, and sufficient ventilation to ensure cooling of the motors. Ambient air temperature should be between 5 and 40 degrees centigrade, non-condensating. Operation outside of these conditions could seriously damage the equipment. If condensation in the motors is likely to occur, open the drain holes in the motor flange (where fitted).
  - 0.2.7** If the equipment were to be stored or taken out of service for a period of time (e.g. 1 week or more), then we would recommend draining the equipment of all water/liquid (with due regard to any local regulations) to prevent frost damage to components. When restarting is required we would recommend commissioning by our authorised service agent.
  - 0.2.8** Ensure the base/foundation/plinth/wall to which the equipment is to be attached has sufficient mass compared to the equipment, in order to avoid noise/vibration transmission. E.g. the mass of the base should be at least five times the mass of the equipment.
  - 0.2.9** Ensure the electrical supply is the correct voltage, current, frequency and type for the equipment supplied and that suitable circuit protection equipment is installed in the supply. Incorrect electrical installation could be an electric shock/burns/fire hazard.
  - 0.2.10** When accessing the control panel/Motor Inverter to make electrical connections adopt anti-static procedures e.g. wear anti-static earthed wristband, to avoid risk of damaging the controller.
  - 0.2.11** All products that are packaged to include Pressure vessel(s)/Hydraulic Accumulator(s)/Expansion Vessel(s) are classed as "Assemblies" under the Pressure Equipment Directive (PED). Where units are despatched with "Loose" vessel(s) for assembly on site it is absolutely essential that they be installed as detailed in the instructions using the fittings provided where appropriate. Failure to observe this will nullify compliance with the PED and may present a safety hazard. Your warranty may also be affected.
  - 0.2.12** Where Hydraulic Accumulator(s)/Expansion Vessel(s) are supplied as a loose item, they must be installed/connected correctly before operating the equipment, otherwise serious damage from over-pressure/pump overheating could occur.
  - 0.2.13** Do not operate this equipment/pumpset prior to commissioning (section 2.2) This could cause irreparable damage to equipment/pumpset/pipework/system components.
  - 0.2.14** Isolate the equipment/pumpset before pressure testing system. Excess pressure could irreparably damage the pressure transducer, pressure switches (where fitted) and the diaphragms of pressure vessel/hydraulic accumulators.
  - 0.2.15** It is the installers' responsibility to ensure subsequent pipework etc can accept the pressures generated by the equipment/pumpset and to install an overpressure safety device into the system with due respect to the suction pressure present on the pumpset, the pump closed valve pressure stated on the pump, the maximum working pressure stated on any of the attached pressure vessels and any other device connected to the system e.g. boilers, calorifiers etc.
  - 0.2.16** When chlorination of the system is carried out, ensure that any residual chlorine is removed by thorough flushing as detailed in the HSE approved code of practice L8, to avoid damaging the equipment/pumpset. The normal level of chlorination is up to 2 parts per million (ppm), but shock dosing for sterilization purposes, at 25-50 ppm for 24-48 hours is acceptable as long as all chlorine is removed once the process is complete. Chlorination beyond these limits could seriously damage pumpset components and WILL NOT be covered by the warranty.
  - 0.2.17** The installer/user is responsible for the installation of the correct earthing and protection according to valid national and local standards. All operations must be carried out by a suitably qualified person.
  - 0.2.18** The equipment is only suitable for earth referenced supplies and must be permanently earthed to avoid electric shock hazard.
-

- 0.2.19 The equipment must be permanently earthed with appropriate sized Earthing.
- 0.2.20 Equipment containing variable speed drives/motors has high earth leakage current >3.5mA and will require additional earth bonding whereby a single conductor of increased size or duplicate earth conductors must be provided.
- 0.2.21 Never perform high voltage resistance tests on control panels, variable speed drives/motors without first disconnecting the panel/drive/motor from the circuit being tested as this will damage the built in electronic components.
- 0.2.22 Equipment containing variable speed drives/motors that has been stored/not powered up for long periods of time (i.e. 1 year or more) may require the variable speed drive/motor capacitors to be reformed. Please contact AquaTech-Pressmain for more information. Failure to reform capacitors will result in drive/motor damage.
- 0.2.23 Metal parts (e.g. heat sinks) may reach temperatures of 90 degrees centigrade.
- 0.2.24 RCD's/ELCB's are not recommended for use with variable speed drives/motors. Where their use is mandatory use type B RCD's. For single phase sets with inverter motors the earth leakage circuit breaker must trip out when earth fault currents with DC content (pulsating DC) occur. For three phase sets with inverter motors the earth leakage circuit breaker must trip out when earth fault currents with DC content (pulsating DC) and smooth DC earth fault currents occur.
- 0.2.25 RCD's/ELCB's suitable for use with variable speed drives/motors are not suitable for personnel protection.
- 0.2.26 EMC - With respect to BS EN61000-3-2 this equipment is defined as 'professional equipment' and therefore the installer/user may need to seek permission from the supply utility to connect this equipment to the public low voltage mains supply.
- 0.2.27 Where "Expansion vessels" are used on Domestic hot water systems (DHWS) or LTHW heating system pressurisation units, the temperature of the fluid returning to the vessels should not exceed 70 degrees Centigrade as this could damage the vessel diaphragm. Where the temperature exceeds 70C an intermediate cooling vessel should be fitted.
- 0.2.28 Where "Expansion vessels" are used on Domestic hot water systems (DHWS) or LTHW heating system pressurisation units, the glycol content in the water must not exceed 50%.
- 0.2.29 Drain cocks/valves and air bleed screws must not be left open as this could cause flooding.



### 0.3 CAUTIONS FOR OPERATION/USER

- 0.3.1 READ GENERAL SAFETY INFORMATION 0.0, WARNINGS 0.1 and CAUTIONS 0.2, 0.3 & 0.4
- 0.3.2 The unit should only be operated/used by a competent person; *A competent person is someone who is technically competent and familiar with safety practices and the hazards involved.*
- 0.3.3 The Owner/User of this equipment has a Legal Responsibility to ensure that it is subject to regular formal inspections. See Section 3. Servicing, for details.
- 0.3.4 Where Hydraulic Accumulator(s)/Expansion Vessel(s) are supplied as a loose item, they must be installed/connected correctly before operating the equipment, otherwise serious damage from over-pressure could occur.
- 0.3.5 The set must not be run until commissioned by an authorised AquaTech-Pressmain agent, this could irreparably damage the pump set and/or system components/pipework connected to it.
- 0.3.6 The pumpset should be left switched ON with the pumps switched to AUTO (where appropriate) for normal operation.
- 0.3.7 Where appropriate the pumpset should not be left in "Hand/Manual" operation for more than 1 minute. This could lead to severe damage of pumpset components and/or pipework system from over-pressure and/or overheating.
- 0.3.8 Ensure pumpset has an adequate water supply at all times to prevent dry running causing pump seal damage and water leakage.
- 0.3.9 Do no attempt to start pumps without liquid in volutes (pumps must be fully primed); mechanical seals must have a film of liquid between faces for proper operation and to prevent damage.



- 0.3.10 Minimum flow rate: Due to the risk of overheating, do not use the pump at a flow below the minimum flow rate. For cold water this is generally 10% of the pump flow rate as displayed on the pump data plate, on the pump body.
- 0.3.11 Portable telephones or other electro-magnetic equipment must not be used near the set to avoid corruption of program and unpredictable operation of unit.



## 0.4 CAUTIONS FOR MAINTENANCE

- 0.4.1 READ GENERAL SAFETY INFORMATION 0.0, WARNINGS 0.1 and CAUTIONS 0.2, 0.3 & 0.4
- 0.4.2 The unit should only be operated/maintained by a competent person; *A competent person is someone who is technically competent and familiar with safety practices and the hazards involved.*
- 0.4.3 Where the set is fitted with Building Management Services (BMS) interconnections, notify the appropriate persons before switching OFF for maintenance or adjustments, to avoid unnecessary alarm conditions occurring. **WARNING:** With pumpset isolator OFF, mains voltage may still be present from BMS system. This constitutes an Electric shock hazard.
- 0.4.4 To prevent seizing, pumpsets must not be left unused for long periods (e.g. 1 week).
- 0.4.5 The pumps must be run regularly to avoid stagnation of water in the pumps/pipework (e.g. daily).
- 0.4.6 Do not vent air from air valves on vessels. These are for adjustment of pre-set cushion pressures. If wrongly adjusted this will lead to incorrect operation of the pumpset and possible damage to pumps, pipework and system components from overheating and over-pressure.
- 0.4.7 Switch OFF pumpset before accessing pumps and/or control panel.



# 1. INSTALLATION INSTRUCTIONS

These instructions are intended for the installer of this pressure booster set. Please follow them carefully.

The unit should only be installed by a competent person; *A competent person is someone who is technically competent and familiar with safety practices and the hazards involved.*

Failure to install the equipment as recommended below could invalidate the warranty provided by AquaTech-Pressmain to the purchaser.

## 1.1 ADDITIONAL WARNINGS

**DO NOT TOUCH ANY LIVE PARTS FOR AT LEAST 5 MINUTES AFTER SWITCHING OFF THE POWER. Failure to observe this will constitute an ELECTRIC SHOCK HAZARD.**

READ GENERAL SAFETY INFORMATION 0.0, WARNINGS 0.1 and CAUTIONS 0.2, 0.3 & 0.4

## 1.2 ADDITIONAL CAUTIONS

1.2.1 READ GENERAL SAFETY INFORMATION 0.0, WARNINGS 0.1 and CAUTIONS 0.2, 0.3 & 0.4.

1.2.2 If there are any anomalies in the installation, the Inverter motors can be stopped manually using the AUTO/STOP button.

## 1.3 PROCEDURE

### 1.3.1 OFF-LOADING AT SITE

**Do not lift pumpset by pipework.** Lift the pumpset by the container pallet using a pallet/forklift or crane by passing strops underneath the skid using spreader bar.

Failure to utilise these facilities could result in damage.

### 1.3.2 LOCATION

If the set is to be installed in an unheated room, ensure that there is adequate frost protection.

The location of the equipment should have adequate drainage, bunding or other appropriate measures to protect assets and the building fabric in the event of leakage or water spillage. Failure to provide such measures may result in water damage to property and assets.

Ensure that location for pumpset provides adequate clear space to accommodate unit with reasonable access to all parts; AquaTech-Pressmain recommend a minimum distance of 500mm all round. There must be sufficient room to: -

- fully open consumer unit/control panel door;
- lift and withdraw pumps;
- withdraw diaphragms from vessels.
- remove manifolds from pumps.

If necessary, provide overhead lifting eyes for possible future use.

Any Hydraulic Accumulator supplied should be located as near as possible to the discharge side of the pumpset.

**Should any of these location conditions not be satisfied AquaTech-Pressmain reserve the right to charge labour on any warranty work required on the pumpset.**

### 1.3.3 FIXING

Install the set on a flat, even and level surface, where practical on a raised plinth to keep set above damp floor.

Locate unit in position; fit anti-vibration mounts if supplied. If necessary, level the base by inserting packing strips adjacent to bolt positions. Firmly attach pumpset to base.

1.3.4 PIPEWORK

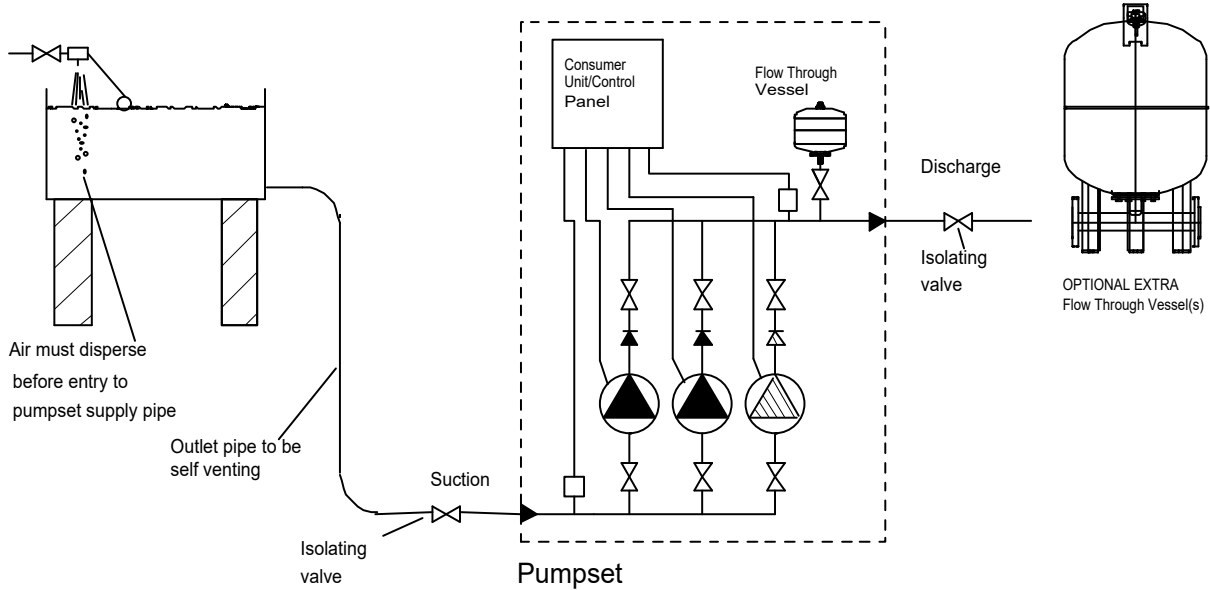

Fig. 1.1 Typical Pipework arrangement

- 1.3.4.1 **Arrange mains water breaktank to ensure fully flooded suction conditions to all pumps within the unit**, unless otherwise specified. Minimum requirement = 0.15 bar (1.5 metres)
- 1.3.4.2 **Arrange the suction pipework to be self-venting** between the mains water breaktank and the pumpset suction manifold (see fig.1.1).
- 1.3.4.3 **Fit isolating valves to the suction side and discharge side of the pumpset** (see fig.1.1), to enable the pumpset to be isolated from the system for maintenance purposes.
- 1.3.4.4 **Under no circumstances fit an extra non-return valve**, to either the suction or the discharge, as it may interfere with the correct operation of the non-return valves already fitted as standard in the pumpset.
- 1.3.4.5 **Remove any protective end plugs from suction and discharge pipework on pumpset.**
- 1.3.4.6 **Connect site pipework to suction and discharge manifolds**, ensuring adequate support is provided to avoid imposing pipe strain on manifolds. The connecting pipework should not be smaller than that of the pumpset. Where flexible pipe connections are fitted, ensure that the correct distance is allowed between flanges, that the pipework is also aligned axially, and no strain is imposed by the site pipework. (see fig.1.2)

MAX PERMISSIBLE MOVEMENT					
BORE OD (mm)	NOM. Length (mm)	AXIAL EXTN (mm)	AXIAL COMP (mm)	SHEAR (mm)	ANGULAR MOVEMENT (DEG)
32	130	4	8	8	15
40	130	4	8	8	15
50	130	5	8	8	15
65	130	6	12	10	15
80	130	6	12	10	15
100	130	10	18	12	15
125	130	10	18	12	15
150	130	10	18	12	15

Compression

Extension

Shear

Angulation

Fig. 1.2 Flexible pipework connections

- 1.3.4.7 **Where Hydraulic Accumulator(s)/Expansion Vessel(s) are supplied as a loose item**, they must be installed/connected correctly before operating the equipment, otherwise serious damage from over-pressure/pump overheating could occur (see also 1.3.5 for correct mounting).
- 1.3.4.8 **All hydraulic accumulators and expansion vessels fitted to the system must have isolating and drain off valves** to enable them to be serviced and removable pipework to enable the diaphragm to be replaced.



**Fig. 1.3a & b Isolation valve on manifold & Flexible hose with drain cock on vessel (non-flow through vessel shown)**

**1.3.4.9** HM2AV and AMV-FB sets with E-SPEED Inverter motors have low water protection built in, no further action is required.

**1.3.4.10** Ensure that any swarf, debris, etc that may have entered the tank is removed as it could cause damage to the tank or connected equipment.

**1.3.5 FLOW THROUGH VESSELS**

HM2AV and AMV-FB sets have 8, 12, 18 or 25 litre flow through vessel(s) supplied loose for site fitting into the discharge manifold via a flowjet isolation and drain valve. The number and size of vessels supplied depends upon the number and size of pumps fitted.

Ensure “O-ring” is in place inside valve to prevent leakage.

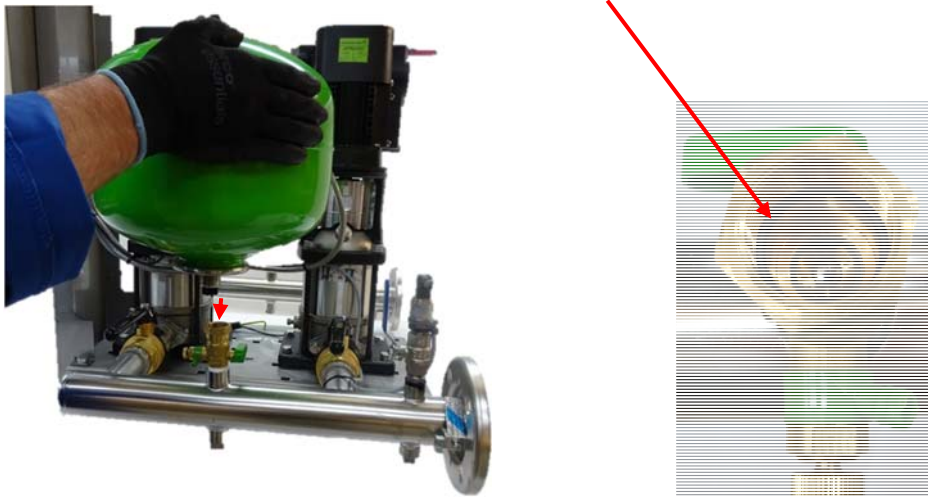

**Fig. 1.4a & b Fit flow through vessel into discharge manifold flowjet valve.**

In order to reduce power consumption still further, we would recommend fitting an additional (optional extra), larger flow through vessel to the discharge pipework of the system. This would store an amount of water at high pressure which would then be released to satisfy small demands from the system thereby reducing the number of pump starts.

Larger floor standing flow through vessels may be provided as optional extra items fitted on site. Sizes available from 60 litre to 3,000 litre with 1 ¼” up to DN100 connection.



**Fig. 1.5 Typical Flow Through Vessels (12l, 300l and 800l shown).**

All vessels must be securely mounted to prevent any movement from imposing strain on the attached pipework. Vessels **MUST** be mounted vertically on the integral legs with water connection lowermost. Set up the vessel so the air charge filling valve (top) and the diaphragm (bottom) are accessible for future maintenance. All vessels must have isolating and drain off valves fitted to enable them to be serviced. The connecting pipework should be removable to give access for replacing the diaphragm and should be the same size as the vessel connection to minimise friction losses. In the case of floor standing vessels, if the system cannot be turned off then supply dual flow through vessels connected in parallel to enable isolation/drainage of one vessel at a time. Contact AquaTech Pressmain for further information.

Set the air cushion pre-charge pressure to the correct level (see section 2.4), dependent on the application required for the vessel. Refer to the Operating parameters at the back of this manual or contact Aquatech-Pressmain for advice.

Caution: If the air cushion pre-charge pressure required exceeds 4.0 Bar then you must follow the procedure shown in section 2.4 to avoid damaging/rupture of the internal diaphragm and consequences of. E.g. High and/or low pressure problems, unstable pump operation.

**1.3.6 ELECTRICAL**

**WARNING: DO NOT TOUCH ANY LIVE PARTS FOR AT LEAST 5 MINUTES AFTER SWITCHING OFF THE POWER TO ALLOW CAPACITORS TO DISCHARGE**

READ GENERAL SAFETY INFORMATION 0.0, WARNINGS 0.1 and CAUTIONS 0.2, 0.3 & 0.4

1.3.6.1 All wiring must comply with the latest edition of local wiring Regulations.

1.3.6.2 **Wear anti-static wrist strap at all times** to avoid static discharge causing problems with the built in electronic program.

1.3.6.3 Connect incoming electrical mains supply to identified terminals on isolator SW1 in consumer unit (see fig. 1.7). Ensure voltages and frequency indicated on the motor nameplates and wiring diagrams correspond with supply mains data and that the supply fuse type & rating is correct for the total current rating of the equipment. Note: some 3 phase units may require Neutral supply for special applications. Refer to wiring diagram supplied with the unit or AquaTech-Pressmain.

Pump Type	kW per Pump	Volts/ Phases/Hz	HM2AV Pump set supply current (Amps)		Pump Type	kW per Pump	Volts/ Phases/Hz	AMV2-FB Pump set supply current (Amps)	AMV3-FB Pump set supply current (Amps)	AMV4-FB Pump set supply current (Amps)
3-5	0.75	230/1/50	25		3-8	0.75	230/1/50	25	32	40
3-5	0.75	400/3/50	20		3-8	0.75	400/3/50	20	20	25
5-5	1.3	230/1/50	25		5-6	1.5	230/1/50	25	40	63
5-5	1.3	400/3/50	20		5-6	1.5	400/3/50	20	25	32
10-5	2.2	230/1/50	40		10-5	2.2	230/1/50	40	63	80
10-5	2.2	400/3/50	20		10-5	2.2	400/3/50	20	25	32

**Table 1, Typical example of pumpset supply sizes.**

1.3.6.4 Where optional remote fault signal is required connect volt free terminals in motor terminal box, to remote panel. See fig 1.7 and wiring diagram provided. Signal relay function will need to be programmed.

1.3.6.5 Complete any required earth bonding.

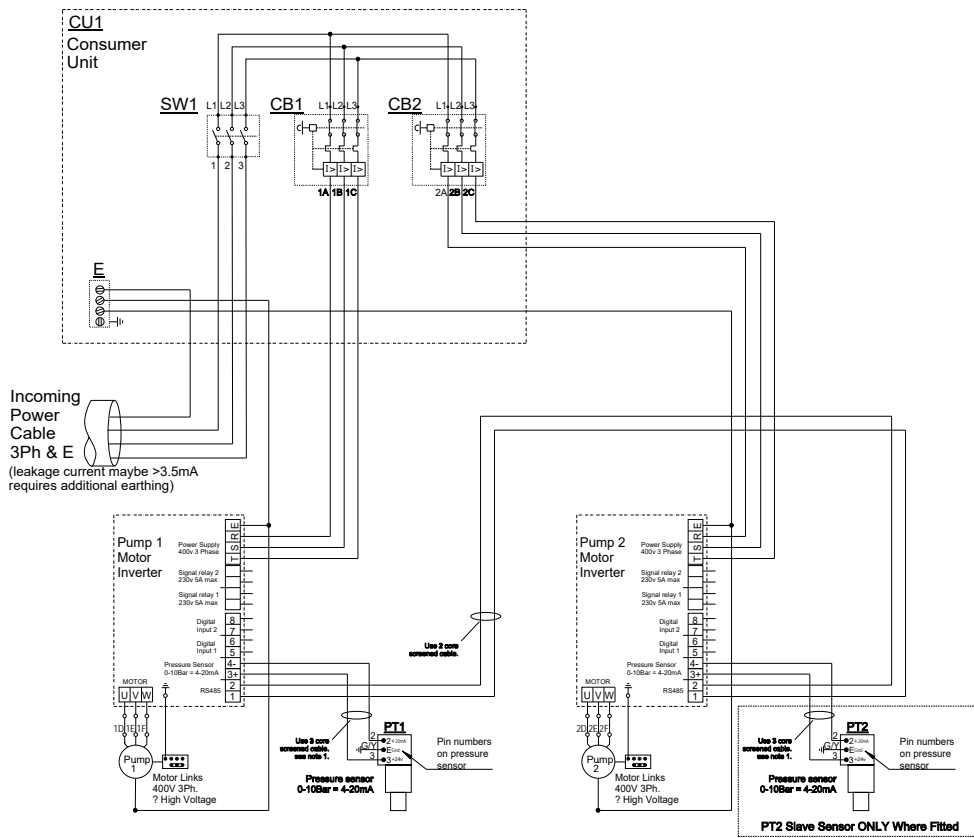





Fig. 1.7 Typical example of HM2AV, AMV2-FB-E-SPEED 400VAC 3 phase electrical connections

### 1.3.7 GUIDANCE ON SELECTING THE CORRECT EARTH LEAKAGE PROTECTION DEVICE FOR BOOSTER SETS

All wiring must comply with the latest edition of local wiring Regulations.

Where the incoming electrical supply to the booster set is to be protected by the customer using an Earth Leakage Protection Device, we would recommend that in order to prevent nuisance tripping, follow the information provided below: -

1. Generally, a booster set with pumps/motors that are single phase “variable speed” should have protection that is of the RCBO style, with a type “C” MCB part (inrush 5-10 x Amp rating) and 30mA class “A” RCD part (residual AC/pulsed DC fault currents) for twin pump sets, or 100/300mA class “A” RCD part (residual AC/pulsed DC fault currents) for triple pump sets. 
2. Generally, a booster set with pumps/motors that are three phase “variable speed” should have protection that is of the RCCB style, with a 30mA or 100/300mA (dependent upon motor size and therefore total leakage current) class “B” RCD part (residual AC/pulsed DC & smooth DC fault currents) which is not of the delayed tripping type.  

Variable speed Motor Size (kW)	Typical example of Leakage Current (mA)
0.75 > 3.0	3.5
4.0 > 5.5	5.0
7.5	10.0
11.0 >	> 10.0

Table 2, Typical example of Leakage currents according to EN61800-5-1

If you require any further assistance, please contact AquaTech-Pressmain.

## 2. USER INSTRUCTIONS

### 2.1 CUSTOMER ASSURANCE

**AQUATECH-PRESSMAIN ASSURE YOU THAT IF ANY PART OF THIS EQUIPMENT BECOMES DEFECTIVE DUE TO FAULTY MANUFACTURE OR MATERIALS WITHIN 24 MONTHS FROM THE DATE OF INVOICE OR 12 MONTHS FROM DATE OF COMMISSIONING BY AUTHORISED AQUATECH-PRESSMAIN AGENT, THE PART WILL BE REPAIRED OR REPLACED.**

The only conditions are: -

- ◆ The equipment must have been installed, commissioned, operated and maintained as recommended by **AquaTech-Pressmain**.
- ◆ The equipment must not have been neglected, misused, modified, or used for any other purpose than its original application.
- ◆ The commissioning should be carried out within 6 months of the date of invoice by an authorised **AquaTech-Pressmain** agent.
- ◆ This Assurance does not apply to those items not supplied by us or to defects arising from parts not made or approved by **AquaTech-Pressmain**. The individual manufacturers own policies for dealing with defects will apply.
- ◆ Any part repaired or replaced under these Assurances will be covered for the balance of the appropriate Assurance period.
- ◆ If we have any disagreement about these Assurances which we are unable to resolve we will both abide by the decision of an agreed Arbitrator or, if we are unable to agree, one appointed by the Building and Engineering Services Association (B & ES) Arbitration Scheme Rules.
- ◆ These Assurances are in addition to, and do not detract from, the contractual rights you have under Statute or at common law.
- ◆ Failure to comply with the installation, commissioning and maintenance procedures will invalidate the warranty.

**For full details please see the AquaTech-Pressmain "CONDITIONS OF SALE"**

### 2.2 COMMISSIONING

Whilst this set has been tested in the factory to the required settings (detailed in operating parameters at the back of instruction manual), it is impossible to simulate the actual on-site conditions, especially if they are unusual. Also, the settings may have been disturbed since leaving the factory.

Therefore, we strongly recommend **the set is commissioned by our authorised agent** who will prepare the set, make any necessary adjustments and leave the set in operational order.

Commissioning is a requirement to validate the Warranty (see Customer Assurance)

Prior to requesting an engineer to attend the site for commissioning, the client must ensure that;

- the equipment has been correctly installed;
- a written scheme of examination has been obtained where required under the Pressure Systems Safety Regulations;
- any necessary chlorination or other treatment has been completed;
- an adequate water supply and permanent electricity supply are available;
- the pipework etc in the building being served by the pumpset is capable of accepting the generated pressures.

## 2.3 OPERATING INSTRUCTIONS

These pumpsets are used for increasing the supply pressure of cold potable water and other liquids.

### 2.3.1 ADDITIONAL WARNINGS

#### **DO NOT TOUCH ANY LIVE PARTS FOR AT LEAST 5 MINUTES AFTER SWITCHING OFF THE POWER**

READ GENERAL SAFETY INFORMATION 0.0, WARNINGS 0.1 and CAUTIONS 0.2, 0.3 & 0.4.

### 2.3.2 ADDITIONAL CAUTIONS

**2.3.2.1** READ GENERAL SAFETY INFORMATION 0.0, WARNINGS 0.1 and CAUTIONS 0.2, 0.3 & 0.4.

**2.3.2.2** If there are any anomalies in the installation, the Inverter motors can be stopped manually using the AUTO/STOP button.

### 2.3.3 NORMAL OPERATION

The pressure booster set increases and maintains the supply pressure to a preset 'Duty' pressure.

The pumpset consists of two or more pumps mounted on a baseframe together with associated suction and discharge pipework and valves. For HM2AV and AMV-FB units, the controls are motor mounted. In all cases they work in conjunction with a hydraulic accumulator.

**2.3.3.1** The display shows the current system pressure and status (speed in Hz, Current in Amps, etc.)



**Fig 2.1 Controls/display (1 per pump motor)**

**2.3.3.2** For “normal” operation, all pump suction and discharge valves should be left open, all hydraulic accumulator/expansion vessel isolating valves should be left open, and drain cock/valves should be left closed. Should it be necessary to have a situation that is not “normal” operation, then we would strongly recommend attendance to site by our trained/authorised service personnel. Please contact AquaTech-Pressmain for more details.

#### **2.3.3.3 Pump Operation**

Intermittent running duty pump with one (or more optional) support pump(s) meeting demand. Pumps are run at Variable speed.

When demand on the system occurs (e.g. when a tap is turned on) the pressure falls as water from the hydraulic accumulator is discharged into the system. The pump operates at the set duty pressure and will run for a set period or until the demand is satisfied and the accumulator is replenished. Should the pressure continue to fall due to increased demand etc. the support pump(s) will automatically start in sequence and run for a set minimum time or until the demand is satisfied.

#### **2.3.3.4 Duty Pump Rotation.**

To spread the wear evenly across all the pumps, their sequence is automatically rotated.

#### **2.3.3.5 Automatic Restart**

If there is an interruption to the electrical supply the unit will automatically restart on restoration of the supply.



### 2.3.3.6 Pressure Setting

The pumpset is set at the required 'duty' pressure at the factory. If necessary, the pressure will be adjusted at commissioning to suit local conditions.

### 2.3.3.7 Dry Running Protection

The pumpset is supplied with low water protection built into the Inverter motor. No further action is required.

## 2.3.4 MENU

By pressing F2 key, you can access the menu (provided the parameters have not been locked). Use UP and DOWN arrows to select sub-menu, F1 to Exit, F2 to Enter sub-menu.



Fig 2.2 Typical Menu displays

1. To view/edit basic parameters such as working pressure.
2. To view data such as hours run, number of starts and power consumption.
3. To display a History Log of Alarms.
4. To run the pump manually (in Hand).
5. Advanced parameters
6. Fine tuning



## 2.3.5 WARNINGS

WARNING SIGN	Cause	Check
The POWER LED blinks.	The pump to which the frequency converter is connected is not operative for automatic running.	Check that there is no manual shutdown (AUTO/STOP button on the keypad), a remote stop (auxiliary input active remote stop) or a general stop of the network of frequency converters (occurs when any general critical parameter is being modified).
The RUN LED blinks.	The frequency converter is in the process of stopping the pump.	
The ALARM LED blinks.	The start-up wizard is running. The pump is in a state of alarm (indicated on the display).	The LED will stop blinking once the initial configuration wizard has finished. Consult the section on Alarms in this manual to resolve the incident.
The current frequency data blinks.	The frequency converter is limiting the rotational frequency of the motor due to a high temperature in the electronics, in addition to excessive consumption of the electric motor.	Consult the section on Alarms in this manual to resolve the incident. Check the frequency converter is properly ventilated.
The stop frequency data blinks.	The stop frequency calculated exceeds the maximum frequency permitted for pump operation	We recommend running the stop frequency setup wizard again. If this warning persists after running the wizard again, you must reduce the working pressure, as the pump that is connected will not be able to reach it.
The current consumption data blinks	The frequency converter is limiting the rotational frequency of the motor	Check that the motor current is that indicated on the specifications plate.
Next to the current pressure data, there is an asterisk that blinks.	The frequency converter with this warning does not have any pressure transducer connected. If there is a transducer connected, it is not connected with the correct polarity. The transducer's reading has a difference of 0.5 bar from the other transducers connected on the network of frequency converters	Disconnect the transducer from the electrical terminal block and invert the polarity of the connecting cable. We recommend changing the transducer because it is not reading correctly

Table 3, Warnings

## 2.3.6 ALARMS

ALARM MESSAGE	Cause	Check
ALARM F01 OVERCURRENT	Indicates excessive consumption in the motor.	Check that the nominal consumption data has been entered correctly. Check that the pump rotates freely with no obstructions.
ALARM F02 SHORT CIRCUIT	The motor is communicated or has burnt out. Not all wires have been connected. Internal fault in the frequency converter.	Disconnect the motor from the frequency converter and check that the message disappears. If this is not the case, contact AquaTech-Pressmain. Check that all the cables of the motor are correctly connected to the motor itself and also to the frequency converter. Also supervise the correct wiring of the frequency converter's power supply. Contact AGM.
ALARM F03 EXCESS TEMPERATURE OF THE MODULE	The power module has reached a very high temperature, compromising its reliability.	Ensure the ambient temperature does not exceed the extremes set out in this manual. If it is assembled on the pump, ensure the pump has a fan and that the fan cover has been fitted. If it is assembled on a wall mount, ensure the fan of the mount functions correctly when the motor is running.
ALARM F04 INPUT VOLTAGE	The frequency converter is not receiving electric current, or is outside of the upper and lower limits.	The electrical supply to the frequency converter has been interrupted. The electrical connection cable from the mains electricity to the frequency converter has been disconnected. The electrical voltage entering the frequency converter is outside the limits.
ALARM F05 TRANSDUCER	The frequency converter does not receive a correct reading from the pressure transducer.	The pressure transducer is wired in the frequency converter with the polarity reversed. The pressure transducer is broken. The pressure transducer has a range other than 4-20 mA.
ALARM F06 MOTOR FAULT	The motor is communicated or has burnt out. Fault/poor connection of the phases	Disconnect the motor from the frequency converter and check that the message disappears. If this is not the case, contact AquaTech-Pressmain. Some of the cables that communicate the motor with the frequency converter are not making good electrical contact. The motor is connected to receive a voltage other than that provided by the frequency converter. The consumption of the input phases is not balanced.
ALARM F07 LOW WATER LEVEL	The frequency converter detects that the pump is working partially at no load.	Ensure the pump aspirates the fluid correctly.
ALARM F08 BURST PIPES	The frequency converter detects that the pump is working at a very low pressure and at a speed high for a time.	Check that the water network has no leaks greater than those required for regular demand
ALARM A09 FREQUENCY PARAMETERS INCOHERENT	There is a parameter related to the frequency in conflict with the values considered normal.	Check that the minimum frequency is greater than 10 Hz. Check that the maximum frequency is lower than 65 Hz.

		<p>Check that the minimum frequency entered is lower than the maximum frequency.</p> <p>Check that the minimum operating frequency for the auxiliary pumps is lower than the maximum frequency.</p> <p>Check that the minimum operating frequency for the auxiliary pumps is greater than the minimum frequency.</p>
ALARM A10 TIME PARAMETERS	The stop delays of the auxiliary pumps exceeds the stop delay of the main pump.	
ALARM A11 PRESSURE PARAMETERS	The start-up pressure differential exceeds the working pressure	Reduce the start-up pressure differential of the pump, or increase the working pressure above this value.
ALARM X13 INTERNAL ERROR	<p>There is no communication between the control panel with the button pad and display, and the power plate screwed into the radiator.</p> <p>Internal fault in the frequency converter</p>	<p>Check that the flat cable that communicates both electronic circuits are well connected and tightened.</p> <p>It may be due to an occasional error in the firmware of the frequency converter or the spot reading of a parameter deemed to be outside of the limits. In this case we recommend cutting the power to the frequency converter for a few minutes. If after a few minutes, when the power is reconnected to the frequency converter, the message remains, contact AquaTech-Pressmain.</p>

**Table 4, Alarms**

### 2.3.7 COMMON FAULTS

#### VENTING PUMPS

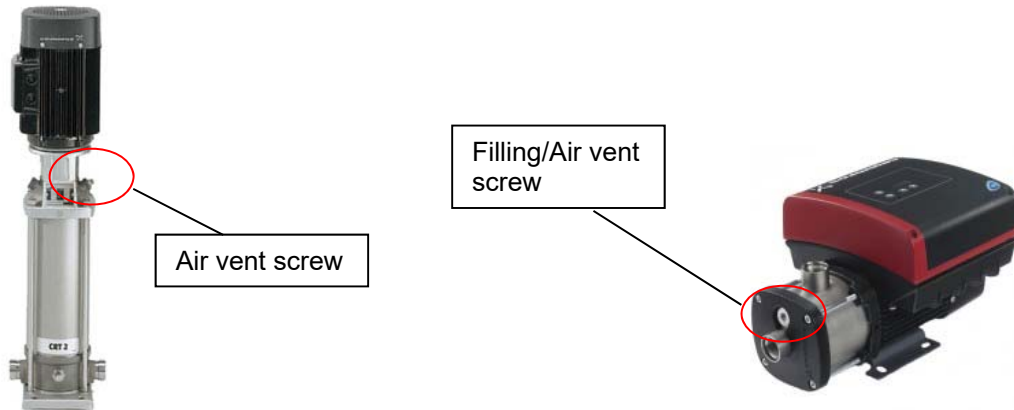

Fig 2.3 Venting Pumps (Multi-Stage type pump shown left, End-Suction type pump right)

To vent pumps:

Isolate pumpset from system by closing a common discharge valve.

**ISOLATE consumer unit/control panel**

Undo air vent screw on each pump body until all the air is released

Re-tighten screws

Switch ON panel isolator.

After pumpset has initialised, **SLOWLY** open discharge valve to bring the pumpset back online.

Note: Failure to close the discharge valve, or reopening it too quickly could cause damage to the system.

**If a problem persists, contact AGM service department quoting the serial number SO: \_\_\_\_\_ (on control panel fascia)**

### 2.3.8 REMOTE SIGNALS

HM2AV & AMV-FB volt free contacts in each Pump motor if configured at time of order (see fig 1.7):

Relay maximum contact load = 230VAC, 5A (Resistive)

## 2.4 MAINTENANCE INSTRUCTIONS

### DO NOT TOUCH ANY LIVE PARTS FOR AT LEAST 5 MINUTES AFTER SWITCHING OFF TO ALLOW CAPACITORS TO DISCHARGE.

#### 2.4.1 ADDITIONAL CAUTIONS

2.4.1.1 READ GENERAL SAFETY INFORMATION 0.0, WARNINGS 0.1 and CAUTIONS 0.2 to 0.4.

#### 2.4.2 PROCEDURE

Every 6 months the pumpset should be maintained by authorised AquaTech-Pressmain service agents - see Servicing (Section 3.)

##### **Pump Lubrication**

Pumps require no lubrication as the impeller shafts are carried on the motor bearings.

##### **Motor Lubrication**

Motor bearings for 0.37 to 7.5kW motors are normally sealed and require no lubrication. Motor bearings for 11 to 22kW motors, should have a grease point, use polycarbamide-based grease, and completely renew every 4000 running hours. Remove the bottom plug in the motor flange and the plug in the bearing cover to ensure that old and excess grease can escape.

##### **Expansion, Control and Hydro Accumulator vessels**

**Air Charge Pressure.** The correct charge pressure provides reliable operation of the system and a prolonged lifetime of the diaphragm. This should be checked regularly. Caution: If the air cushion pre-charge pressure required exceeds 4.0 Bar then you must follow the procedure shown below to avoid damaging/rupture of the internal diaphragm and consequences of. E.g. High and/or low pressure problems, unstable pump operation.

1. **To adjust air charge pressure < 4.0Bar:** isolate the vessel from the system and release pressure on water side by opening the drain cock disposing of the water-mix in the appropriate manner. The water inside the bladder will be pushed back by the air charge pressure. Remove cap on the filling valve, set air charge pressure refilling using dry air or nitrogen. Screw cap firmly on filling valve. Close the drain cock and slowly open water connection to the system.
2. **To adjust air charge pressure > 4.0Bar:** If vessel is already in use then isolate hydraulically, reduce the air charge to 4.0Bar then evacuate the water side of the vessel followed by evacuation of the air side. With the vessel empty of water and air, set the air charge pressure (using dry air or nitrogen) to 4.0Bar, bring the water side pressure up to 5.0Bar and close isolating valve, then add more air until the air side pressure is equal to the required pre-charge pressure multiplied by 1.2 e.g. for a pre-charge pressure of 6.0Bar after filling vessel with air to 4.0Bar followed by water to 5.0Bar, fill the air side to  $6.0 \times 1.2 = 7.2$ Bar. Screw cap firmly on filling valve and slowly open isolating valve & water connection to the system.

**LEAVE SET WITH ALL PUMPS SWITCHES IN THE AUTO POSITION,  
THE MAINS SUPPLY SWITCHED ON,  
AND THE SYSTEM CONNECTION OPEN**

## 3. SERVICING

### 3.1 MAINTENANCE AND CARE OF YOUR EQUIPMENT

The AquaTech-Pressmain equipment that is described in this instruction booklet has been manufactured and tested to the highest standards of design and quality. It will give trouble free operation over many years provided it is maintained regularly from when it is commissioned. To keep it operating efficiently in a safe, economical and environmentally friendly condition, regular maintenance is an essential part. AquaTech-Pressmain along with its' service division, AGM Pressurisation Services are the official providers of commissioning and maintenance services. (see below). Several companies operating under the Aquatronic Group Management structure are available to fulfil a wide range of servicing and maintenance requirements, as detailed below.

### 3.2 LEGAL REQUIREMENTS

Hydraulic Accumulators/Expansion Vessels installed as part of/in conjunction with this equipment, with Pressure x Volume above 250 Bar-litres, require formal inspection in accordance with a "Written Scheme of Examination". This is a Legal Requirement on the part of the Owner/User under the "Pressure Systems Safety Regulations" (PSSR). A "Written Scheme" and regular inspection can be provided by either AGM Pressurisation Services (combined maintenance and inspection) or ESIS Ltd (inspection only), see details below.



**Plant Servicing & Inspection**  
**AGM PRESSURISATION SERVICES,**  
 AGM House, Essex, CO6 1GT. **Ph: 01206 215151**  
 10 Wheel Forge Way, Manchester. M17 1EH. **Ph: 0161 226 4727**

AGM provides maintenance and installation of all types of packaged water pumping equipment for building services. Its specialist fields are Pressure booster equipment and sealed systems for heating and chilled water distribution systems.

Regular servicing of any plant for essential services is vital because wear and tear are very gradual processes. With preventative maintenance, the costs are small and benefits in reliability, safety and economy can be significant. AGM Pressurisation Services can provide a complete package of schemes for preventative maintenance on all AquaTech-Pressmain and other makes of equipment.



**Pressure Vessel Inspection**  
**ESIS ENGINEERING SAFETY & INSPECTION SERVICES LTD,**  
 AGM House, London Rd, Copford, Colchester, Essex, CO6 1GT.  
**Phone: 01206 215141**

Under the Pressure Systems Safety Regulations, expansion vessels and hydraulic accumulators, generally 250 bar-litres and greater, and protection devices, require a Written Scheme of Examination before they can be operated. ESIS Inspection and Insurance Services Limited specifications can provide the means to comply with these regulations. These services can be extended to cover other units e.g. air pressure receivers etc.

### 3.3 SERVICE CONTACTS

**For service during warranty period contact: AQUATECH-PRESSMAIN Service Department**  
**Head Office Tel: 01206 215121**

**For regular servicing, contact service division: AGM PRESSURISATION SERVICES**  
**Head Office Tel: 01206 215151 Manchester Office Tel: 0161 226 4727**

who will be pleased to give you expert advice on this or any other servicing matter.



## 4. DISPOSAL

Disposal of this product or parts of it must be carried out in accordance with the following guidelines:

Use the local public or private recycling/waste collection service.

In case such a recycling/waste collection service does not exist or cannot handle the materials used in this product, please deliver the product or any hazardous material from it to your nearest AquaTech-Pressmain office.

### EU Declaration of Conformity

We, Aquatronic Group Management Plc, declare that the equipment detailed below:

**PRESSURE BOOSTER SET**

**MODEL: HM2AV, AMV (1-4)-FB-E-SPEED**

**according to drawing**

**A12289**

Complies with the requirements of the following European Directives:

**Pressure Equipment Directive 2014/68/EU (PED)**

**Machinery Directive 2006/42/EC**

**Low Voltage Directive 2014/35/EU**

**Electro Magnetic Compatibility Directive 2014/30/EU**

**PED Conformity Assessment Modules**

**Module B : Certificate No. CE 641230**

**Module D : Certificate No. CE 641231**

**Notified Body conducting the Conformity Assessment:**

**BSI**

**Kitemark Court**

**Knowlhill**

**Milton Keynes**

**MK5 8PP**

**Notified Body No. 0086**



8/2/19

I.D. Taylor, I.Eng. MIET, Director

Aquatronic Group Management Plc

T/A AquaTech-Pressmain

AGM House, London Rd, Copford, Colchester, Essex CO6 1GT UK

Telephone: 01206 215121

# OPERATING PARAMETERS

**SERIAL No.** ..... **MODEL** .....

THE SERIAL & MODEL NUMBERS MUST BE QUOTED WHEN REQUESTING ASSISTANCE

**ELECTRICAL DATA:**

Supply ..... volts ..... Ph ..... Hz

Full load current of pumpset ..... Amps

Max. pumpset loading: ..... Kw Method of starting: Variable speed

**NOISE LEVEL:** less than 70 db(A) unless otherwise stated .....

**NOMINAL FLOW RATE:** ..... litres/sec

**PRESSURE SETTINGS:**

**AS FACTORY SET**

..... bar ..... secs

Pump Duty pressure .....

Hyd. Accumulator: .....

Pump closed valve press. ....

❖ AMENDED AT COMMISSIONING	
bar	secs
.....	
.....	
.....	

❖ On commissioning it may be found necessary to modify these settings. Providing this information is left with the equipment, the figures will be updated by the commissioning engineer.

Updated by commissioning engineer ..... Date .....