

---

## HEATING & CHILLED SYSTEM PRESSURISATION UNITS

---



### AQUAPACK AP SERIES



# HEATING & CHILLED SYSTEM PRESSURISATION UNITS

## AQUAPACK AP SERIES TWIN PUMP PRESSURISATION UNIT with Microprocessor Control

### Standard Features

- Boiler ratings up to 5000kW @ 82°C
- System contents up to 50,000 litres
- Temperature range up to 120°C (when using intermediate cooling vessel)
- Cold fill pressure 0.8 bar to 3.5 bar (AP3) or 3.5 bar to 7.0 bar (AP7)
- Reliable 2020Plus Microprocessor/transducer control
- Boiler / Chiller safety interlock relay
- Audible alarm with mute & reset operates on high & low pressure
- Expansion vessels - max working pressure 10 bar
- Twin pump models with duty/standby pumps & automatic alternation of duty pump to even wear
- All models are Enhanced and are fully compatible with Building Management Systems
- Fluid category 5 (water supply regulations 1999)
- Designed and built to latest CE requirements and in accordance with ISO9001
- Leak detection via frequency of starts alarm

### General

The Aquapack AP Series pressurisation unit is designed to maintain a minimum set pressure in a sealed heating or chilled water system. Once the system has been initially filled via an RPZ valve or quick filling loop, should the pressure fall below the cold fill pressure the unit operates automatically to restore that pressure. If high or low-pressure conditions should occur the boiler/chiller operation can be interrupted via the volt-free contacts provided. The unit is used in conjunction with

a suitably sized expansion vessel from our Aquatank range of replaceable diaphragm vessels. All packaged equipment is manufactured in accordance with ISO9001 quality assurance procedures.

### Standard Specification

Aquatech Pressmain AP Series, heating or chilled water pressurisation unit. Suitable for cold fill pressures up to 3.5 bar/50psi AP3 and 7.0 bar/98psi with AP7 model. Controlled by Aquatech Pressmain 2020Plus micro-processor controller with pressure transducer for long-term reliability and accuracy, non-volatile EPROM memory and data logging function. Fully packaged unit incorporating; twin pressurisation pumps, auto change-over to even wear; Solid state pump drives with thermal overload protection; Automatic periodic pump pulsing to prevent pump seizure; Combined high/low system pressure cut-out relay volt-free contact; RS232 or 422/485 serial communications port; 18-litre mains water break-tank with 15mm float valve having a type AA air gap to Water Supply Regulations 1999; Fascia controls to provide indicating lights for each pump condition or status, run, hand, off, auto; "User friendly" Fascia keypad to enter & set operational parameters, reset alarm & mute; "Plain English" 2 Line LCD illuminated display.

Automatic cut-out and reset on tank low water level to prevent pump from dry running, 8 BMS Volt free relay connections, Fascia lights for pump tripped condition.

All controls contained within a powder coated sheet steel dust and damp proof enclosure to IP55.

### Electrical Supply

Single Phase, 240 Volt AC, 50Hz, 7 Amp; Max power: 1.1kW. 3 phase, 60Hz options available on request.

## AP OPTIONS



### AP-DS Dual System Pressurisation Unit

As standard specification (above) but fitted with two sets of controls for operating two separate sealed systems. Each system is monitored and controlled independently with dedicated controls so each can have different working parameters while still utilising the dual pump arrangement.

Individual display and BMS monitoring are provided for each system.

### AP-DG Pressurisation Unit with Vacuum Degasser

As standard specification above with integrated active vacuum degassing.

Fully automatic with digital step control to remove dissolved gasses from the sealed system.

See back page for Model Guide.

# QUICK SELECTION GUIDE with example

**Example** 4 storey building with 400 kW boiler power running at a temperature of 80°C Flow and 70°C return. The plantroom is on the ground floor.

**From chart 1** 'Superimposed' pressure at 80°C is 0.2 bar.

**From chart 2** Static height is taken as 4 storeys at 3 metres per floor = 12 metres = 1.2 bar. Plus superimposed pressure of 0.2 bar (from chart 1) equals 1.4 bar, which is our low pressure alarm point. Add 0.2 bar for support pump start, plus 0.2 bar for duty pump start, plus 0.2 bar for duty pump stop. therefore cold fill pressure = 1.2 + 0.2 + 0.2 + 0.2 + 0.2 = 2.0 bar.

**From chart 3** Cross reference 400 kW boiler power (assuming 10 litres per kW for system content) with 2.0 bar cold fill pressure, gives pressurisation unit model.

**From chart 4** Cross reference 400 kW with boiler flow temperature of 82°C gives expansion vessel size 500VR.

**Model selected** Aquapack AP3, complete with 500VR expansion vessel.

**CHART 1**  
EXPANSION & SAFETY PARAMETERS  
FOR HEATING PRESSURISATION UNITS

	FLOW TEMPERATURE °C	EXPANSION PERCENTAGE %	SUPERIMPOSED PRESSURE BAR
<b>LTHW</b>	40	0.78	0.2
	50	1.21	0.2
	60	1.71	0.2
	70	2.28	0.2
	<b>*Example</b> 80	2.91	0.2
<b>MTHW</b> <i>*see note below</i>	100	4.35	0.3
	105	4.77	0.6
	110	5.15	0.9
	115	5.62	1.3
	120	6.01	1.7

\*Must use intermediate cooling vessel.  
Consult with Aquatech Pressmain Sales Office.

**CHART 2**  
PRESSURE SETTINGS CHART FOR HEATING SYSTEM PRESSURISATION EQUIPMENT

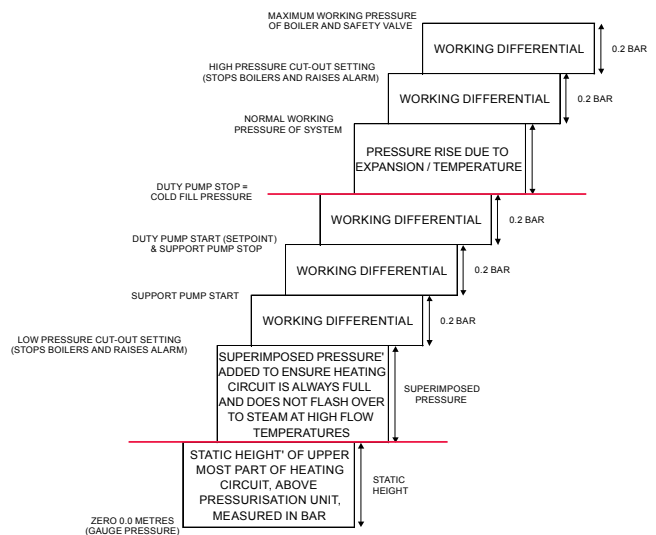

**CHART 3**  
PRESSURISATION UNIT SELECTION

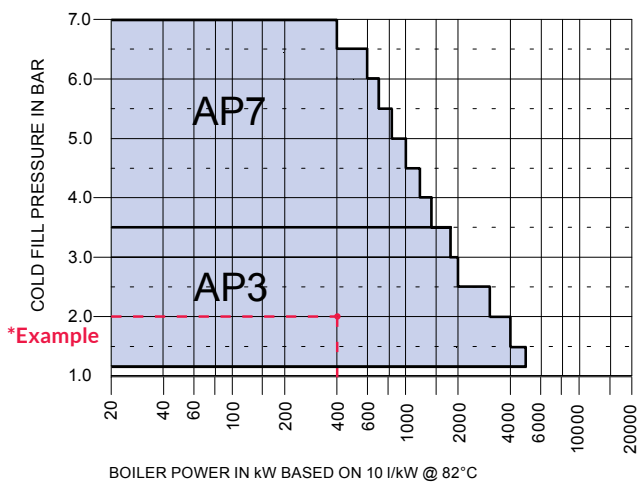

**CHART 4**  
EXPANSION VESSEL SELECTION

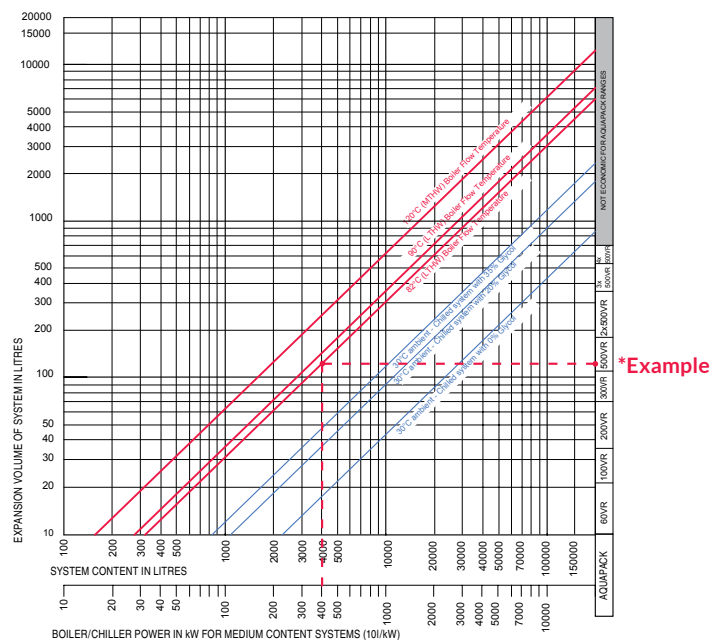

# AP SERIES DIMENSIONS

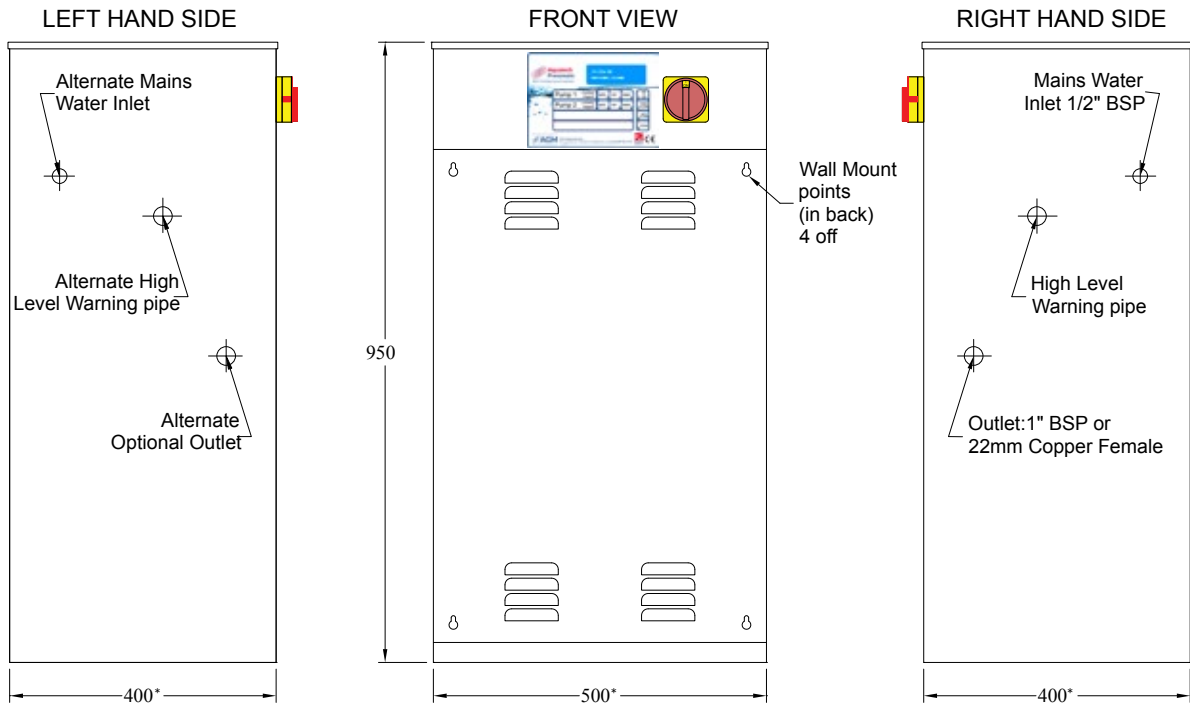

\*For AP-DG versions this dimension is 600mm. All dimensions in mm unless otherwise stated. Alternate inlet/outlet positions must be requested at time of order. Extra cost may apply.

# TYPICAL SCHEMATIC LAYOUT DIAGRAM

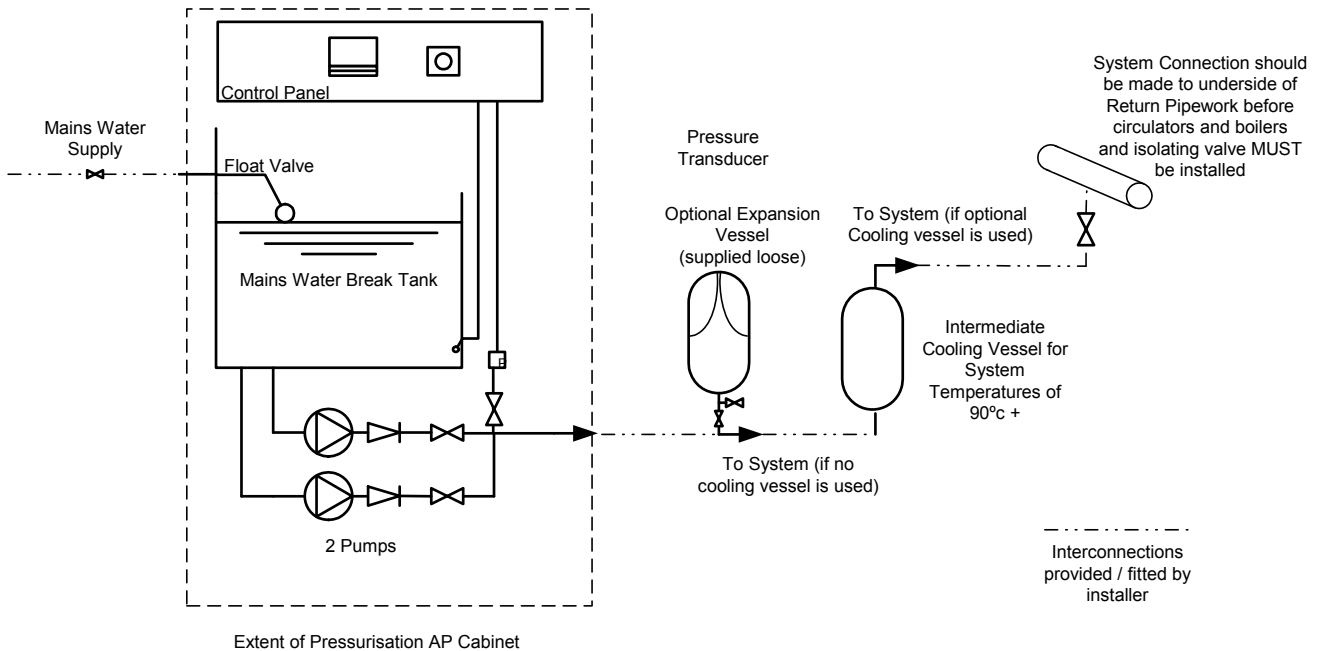

# WORK REQUIRED ON SITE

Bolt unit to plinth or wall.  
 Connect 1/2" BSP (15mm) mains water supply.  
 Provide and fit 3/4" BSP (22mm) overflow pipe from break tank to suitable drain.

Wire single phase control supply onto terminals provided and boiler/chiller thermostat control circuits onto boiler/chiller relay within the control panel.  
 Connect Aquapack unit to system as installation instructions.

# FASCIA DISPLAYS & BMS OUTPUTS

## Operational Data Display

- System Pressure
- System Status Including Warnings
- Alarms With Type of Fault
- Pump/s Tripped
- Transducer Fault
- Boiler/s Cut-out
- High and low tank level

## Information Displays

- Hours Run for Each Pump
- Hours Elapsed Since Last Service
- Parameter Settings Display
- High Pressure Cut-out Setting
- Pump Stop (Cold Fill Pressure)
- Low Pressure Cut-out Setting
- Support Pump Delay Time

## \*Warning Displays

- High Pressure Approach
- Low Pressure Approach
- Servicing Reminder

## BMS Volt Free Relay Connections

- High System Pressure
- Low System Pressure
- Low/High Water Level
- Excessive Frequency of Start/Demand
- Pump Tripped/Failed
- Transducer Fault
- Common Warning Signal for all Warning Displays\*
- Boiler/Chiller Cut-out

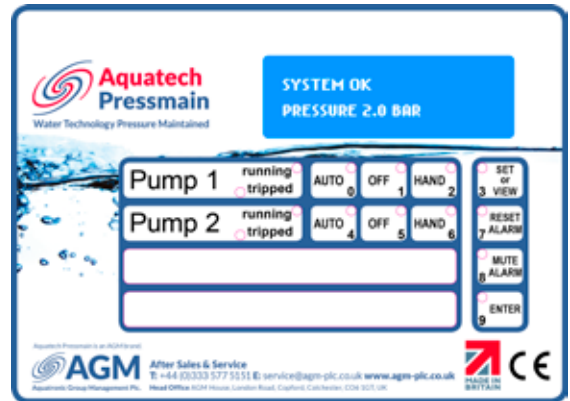

# ELECTRICAL CONNECTIONS

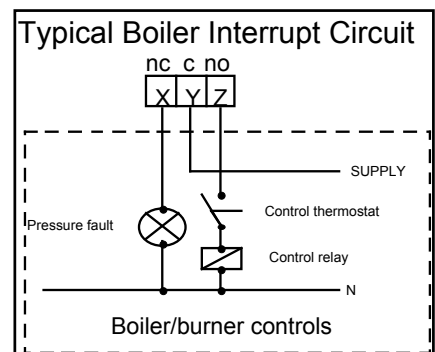
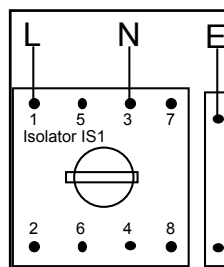
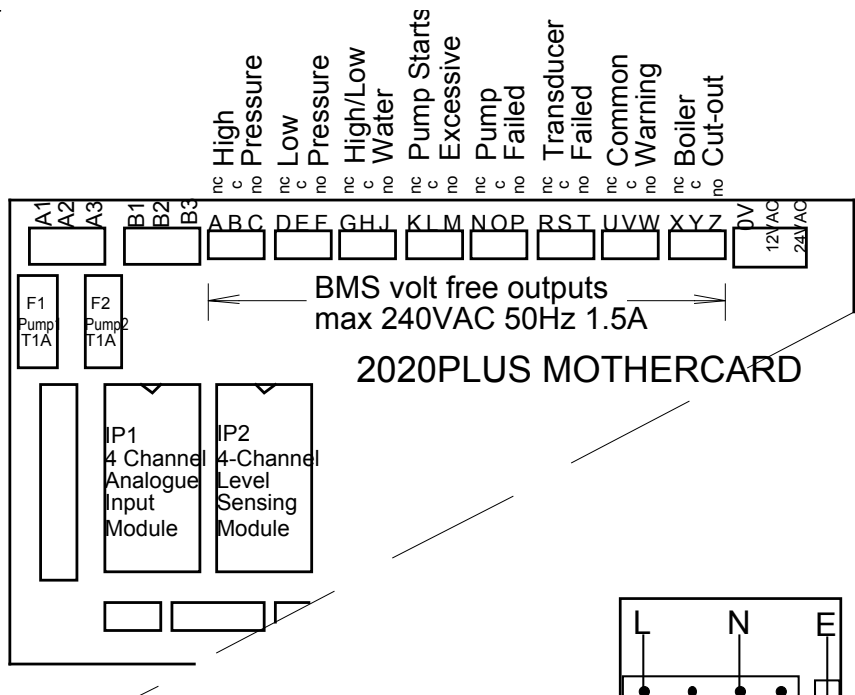

WIRING BY CUSTOMER

## QUICK MODEL GUIDE

AP MODEL	TYPE	FILL PRESSURE	WEIGHT	STOCK CODE
AP3	Single System PU	3.5 Bar	45kg	APA-220300S
AP7	Single System PU	7.0 Bar	45kg	APA-220700S
AP3DG	Single System & De-Gassing PU	3.0 Bar	57kg	APG-220300
AP6DG	Single System & De-Gassing PU	6.0 Bar	57kg	APG-220600
AP3DS	Dual System PU	3.5 Bar	46kg	APD-220300
AP7DS	Dual System PU	7.0 Bar	46kg	APD-220700

## PRESSURE VESSEL DIMENSIONS (SUPPLIED LOOSE)

The diaphragm vessels for special applications; Meets or exceeds EC norms for pressure vessels 97/23/EC; Max working pressure: 10 bar; Vessel Material: Steel RSt 37-2.; All vessel parts in contact with water are coated against corrosion; Diaphragm: Made of special high quality rubber material; Filling Valve: Schraeder-valve-type; Surface Treatment: Blue, durable powder coating finish.

TYPE	25	60	100	200	300	500
Nominal Content - litres	25	60	100	200	300	500
D mm	280	409	480	634	634	740
D1 mm	228	-	-	-	-	-
H mm	484	740	835	975	1270	1475
Water Connection DN BSP	1"	1"	1"	1 1/4"	1 1/4"	1 1/4"
Dry Weight Kg	5.6	14	19	47	53	79
Max. working Pressure-bar	10	10	10	10	10	10

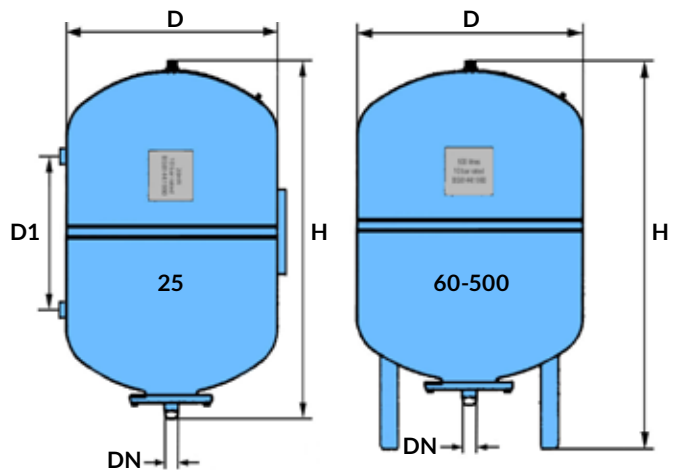

## CONSTRUCTION STANDARDS FOR AQUAPACK AP SERIES

COMPONENT	MODEL/SERIES	STANDARDS/CLASS	REMARKS
Quality System	Manufacturing	ISO 9001:	Cert No. FM33090
Wiring Standards		BS EN 60204: Part 1:1998	
Machinery Directive		European Directive 89/392/EEC: 1994	
EMC Directive		European Directive 89/392/EEC: 1992	
Mains Water Breaktank	18 Litres Nominal Capacity	Fluid Cat 5 Protection	WRC Approved
Mains Float Valve	0.5"	BS1212 part 2	Type 'AA' Air Gap
Pipe Fittings		TUV 9205-8323-501	
Pumps	3/6/7	Peripheral	240v, 1 ph, 50hz
Pump Motors	3/6/7	TEFC IP44, Class F Insulation	Thermal Overload Protected
Control Cabinet	AP	IP55	Steel Powder Coated
Microprocessor Enhanced	2020+ Mothercard	89/336/EEC	BMS Compatible
Transducer Control	392	SS/Ceramic	25 Bar Max. Test Pressure



**Head Office** AGM House, London Road, Copford, Colchester CO6 1GT  
**T:** +44 (0)1206 215121 **F:** +44 (0)1206 215131

**Manchester Office** Unit 10 Wheel Forge Way, Ashburton Road West, Manchester, M17 1EH, UK  
**T:** +44 (0)161 226 4727 **F:** +44 (0)161 226 5848

**E:** info@aquatechpressmain.co.uk **www.aquatechpressmain.co.uk**

The information in this specification is correct at time of issue; as Aquatech Pressmain design and development programmes are continuous, we reserve the right to make any changes to this specification without prior notice.