

INSTRUCTIONS FOR

0. GENERAL SAFETY INFORMATION, WARNINGS & CAUTIONS
1. INSTALLATION
2. THE USER
3. SERVICING
4. DISPOSAL

AQUAPACK AP-DG COMBINED PRESSURISATION AND DEGASSING UNITS MODELS: AP(3-8)-DG



XLM-200115 ISSUE 4 1/01/2021

Head Office: AGM House, London Rd, Copford, Colchester, Essex CO6 1GT UK
Tel: 01206 215121 Email: aftersales@agm-plc.co.uk



PED (Pressure Equipment Directive) Compliant
BSI Certificates CE 641230 & 641231



PRODUCT IDENTIFICATION

All units described in this manual are used to automatically maintain pressure in a pressurised heating or chilled water system and are combined with Automatic Degassing of the system water.

Please note that the Serial Number "SO/WNxxxxx" and model reference will be visible on the unit's control panel fascia label and on the back page of the manual supplied with the unit.

Examples of units are shown below.

Please note: it is also possible for the control panel only or pump unit only to have been sold as a separate item, in which case the O&M manual and CE declaration may only be applicable in part.



AquaPack AP3-DG (3.0Bar max cold fill) or AP6-DG (6.0Bar max cold fill) Twin Pump Pressurisation unit with Automatic Degassing feature built in.



500 litre loose expansion vessel for installing with pump unit. (70°C continuous rated)



500 litre solar expansion vessel. (100°C rated)









AP3-DG (rear view)

Model number examples: -

AP	-DG	Combined pressurisation & degassing unit
3		3.0Bar maximum cold fill pressure
6		6.0Bar maximum cold fill pressure
8		8.0Bar maximum pressure (DO NOT exceed 7.0Bar cold fill pressure!!)

NOTE: although the pumps are capable of a cold fill pressure of 8.0Bar it is not practical to cold fill to this pressure as the air vent maximum operating pressure is 8.0Bar. So **8.0Bar is the maximum working pressure of the unit** once system expansion has taken place!

CONTENTS

PRODUCT IDENTIFICATION	2
 0. GENERAL SAFETY INFORMATION 	5
0.1  WARNINGS	5
0.2  CAUTIONS FOR INSTALLATION	6
0.3  CAUTIONS FOR OPERATION/USER.....	8
0.4  CAUTIONS FOR MAINTENANCE	9
1. INSTALLATION INSTRUCTIONS	10
1.1 GENERAL.....	10
1.2 ADDITIONAL WARNINGS & CAUTIONS	10
1.3 PROCEDURE	10
1.3.1 OFF-LOADING AT SITE.....	10
1.3.2 LOCATION	10
1.3.3 FIXING.....	10
1.3.4 PIPEWORK.....	11
1.3.5 EXPANSION, CONTROL and HYDRAULIC ACCUMULATOR VESSELS	13
2. USER INSTRUCTIONS	15
2.1 CUSTOMER ASSURANCE	15
2.2 COMMISSIONING.....	16
2.3 OPERATING INSTRUCTIONS.....	16
2.3.1 ADDITIONAL WARNINGS & CAUTIONS	16
2.3.2 NORMAL OPERATION.....	16
2.3.3 SYSTEM WARNINGS.....	21
2.3.4 SYSTEM ALARMS	22
2.3.5 REMOTE SIGNALS on BMS Enhanced models only.....	23
2.3.6 RESETTING PARAMETERS	23
2.3.7 SERVICING REMINDER	23
2.4 MAINTENANCE INSTRUCTIONS.....	23
2.4.1 PROCEDURE.....	23
3. SERVICING	24

4. DISPOSAL..... 25

EU DECLARATION OF CONFORMITY 25

OPERATING PARAMETERS..... 26



0. GENERAL SAFETY INFORMATION



- These instructions are intended for the installer/operator/user/maintenance of this equipment and must be kept with the equipment, for the life of the equipment and made available to all persons. Please read GENERAL SAFETY INFORMATION 0.0, WARNINGS 0.1 and CAUTIONS 0.2, 0.3 & 0.4 before doing anything else, and then follow them carefully.
- The unit must only be installed/operated/used/maintained by a competent person; *A competent person is someone who is technically competent and familiar with safety practices and the hazards involved.*
- Hydraulic Accumulators/Expansion Vessels installed as part of/in conjunction with this equipment, with Pressure x Volume above 250 Bar-litres, require regular formal inspection by a *competent person*. This is a Legal Requirement under the "Pressure Systems Safety Regulations" (PSSR) and the Owner/User should be made aware of their responsibility for this. (see section 3. Servicing).
- Failure to install/operate/use/maintain the equipment as recommended below could cause damage to the equipment any anything subsequently connected to it, and invalidate the warranty provided by AquaTech-Pressmain to the buyer.
- Any damage caused to the equipment by misapplication, mishandling or misuse could lead to risk of **Electrocution, Burns, Fire, Flooding or injury to people or property** dependent upon the circumstances involved.
- This equipment contains moving/rotating parts that must remain guarded. Removal of or missing guards could lead to serious personal injury.
- This equipment automatically restarts after a power interruption.
- We accept no responsibility or liability for any consequences or damage/losses due to misapplication, mishandling or misuse of the equipment.
- It should be noted that the assembly of pressure equipment on site under the responsibility of the user (or his representative) is not subject to the Pressure Equipment Directive 97/23/EC. (National legislation covering assembly on site will apply)
- The latest version of this instruction manual with up to date safety information can be downloaded from our website at www.aquatechpressmain.co.uk



0.1 WARNINGS

- 0.1.1 **Do not touch any live parts for at least 5 minutes after switching off the electricity supply. Failure to observe this will constitute a severe Electric shock and/or Burns hazard and may be lethal.**
- 0.1.2 **The equipment is only suitable for earth referenced supplies and must be permanently earthed to avoid Electric shock hazard.**
- 0.1.3 **With equipment isolator OFF, mains voltage may still be present from BMS system. This constitutes an Electric shock hazard.**
- 0.1.4 **Emergency stop button does not remove dangerous voltages from control panel/pump motor assemblies. This constitutes an Electric shock hazard.**
- 0.1.5 **Metal parts (e.g. heat sinks) may reach temperatures of 90 degrees centigrade and will constitute a Burns hazard.**
- 0.1.6 **Some equipment is designed to operate with liquid temperatures up to 200 degrees centigrade and will constitute a Burns/scalding hazard.**

- 0.1.7 The equipment must not be pressurised beyond the maximum working pressure as stated on pumps/pipework/vessels/control panel otherwise serious mechanical damage/destruction could occur causing injury to people or property.
- 0.1.8 The equipment must not be heated/chilled beyond the maximum/minimum working temperature as stated on pumps/pipework/vessels/control panel otherwise serious mechanical damage/destruction could occur causing injury to people or property.
- 0.1.9 Any damage to equipment, pumpset, vessels, pipework or system components caused by misapplication, mishandling or misuse could lead to Electric shock hazard, Burns hazard, Fire hazard, Flooding hazard or cause injury to people or property.
- 0.1.10 This equipment may contain moving/rotating parts that must remain guarded. Removal of or missing guards could lead to serious personal injury.
- 0.1.11 Pressure vessels must never be disassembled whilst in use, they contain high pressure air/gas charge which could cause injury to people or property.
- 0.1.12 Pump motors with lifting eyes; the lifting eyes are only suitable for lifting motors NOT the entire pump assembly. This could cause injury to people or property.
- 0.1.13 Ensure the base/foundation/plinth/wall to which the equipment is to be attached is sufficiently strong enough to carry the entire mass of the equipment including the water that it will contain under worst-case fault conditions. E.g. fully saturated pressure vessel with no air charge, break/spill tank full to overflowing, etc. Failure to observe this could cause serious mechanical damage/destruction resulting in injury to people or property.
- 0.1.14 This equipment contains a fluid which may under certain circumstances leak/drip/spray fluid (e.g. servicing, repair or malfunction). Ensure any fluid discharge will not cause damage to the surroundings by taking appropriate action. E.g. install in a place that will not be damaged by leakage or install in a bunded area with adequate drainage.



0.2 CAUTIONS FOR INSTALLATION

- 0.2.1 READ GENERAL SAFETY INFORMATION 0.0, WARNINGS 0.1 and CAUTIONS 0.2, 0.3 & 0.4
- 0.2.2 The unit should only be installed/operated by a competent person; *A competent person is someone who is technically competent and familiar with safety practices and the hazards involved.*
- 0.2.3 Do not lift the pumpset by pipework. Lift the pumpset by the container pallet using a pallet/forklift or crane by passing strops underneath the skid using a spreader bar. Failure to utilise these facilities will result in damage to the pumpset.
- 0.2.4 Store in a dry place to avoid damp conditions deteriorating the equipment.
- 0.2.5 Protect against dirt, damage and frost. It is absolutely essential that no foreign matter such as pipe thread swarf, welding slag, grit or stones are allowed to enter the equipment. Debris of this type can cause severe damage to the mechanical seals, diaphragms and impeller. Frost/freezing will damage pumps/pipework and control panel components.
- 0.2.6 The equipment is only suitable for installation in a clean, dust free indoor environment, with adequate protection from heat and frost, and sufficient ventilation to ensure cooling of the motors. Ambient air temperature should be between 5 and 40 degrees centigrade, non-condensating. Operation outside of these conditions could seriously damage the equipment.
- 0.2.7 If the equipment were to be stored or taken out of service for a period of time (e.g. 1 week or more), then we would recommend draining the equipment of all water/liquid (with due regard to any local regulations) to prevent frost damage to components. When restarting is required we would recommend commissioning by our authorised service agent.
- 0.2.8 Ensure the base/foundation/plinth/wall to which the equipment is to be attached has sufficient mass compared to the equipment, in order to avoid noise/vibration transmission. E.g. the mass of the base should be at least five times the mass of the equipment.
- 0.2.9 Ensure the electrical supply is the correct voltage, current, frequency and type for the equipment supplied and that suitable circuit protection equipment is installed in the supply. Incorrect electrical installation could be an electric shock/burns/fire hazard.

-
- 0.2.10** When accessing the control panel to make electrical connections adopt anti-static procedures e.g. wear anti-static earthed wristband, to avoid risk of damaging the controller.
 - 0.2.11** All products that are packaged to include Pressure vessel(s)/Hydraulic Accumulator(s)/Expansion Vessel(s) are classed as “Assemblies” under the Pressure Equipment Directive (PED). Where units are despatched with “Loose” vessel(s) for assembly on site it is absolutely essential that they be installed as detailed in the instructions using the fittings provided where appropriate. Failure to observe this will nullify compliance with the PED and may present a safety hazard. Your warranty may also be affected.
 - 0.2.12** Where Hydraulic Accumulator(s)/Expansion Vessel(s) are supplied as a loose item, they must be installed/connected correctly before operating the equipment; otherwise serious damage from over-pressure/pump overheating could occur.
 - 0.2.13** Do not operate this equipment/pumpset prior to commissioning (section 2.2) This could cause irreparable damage to equipment/pumpset/pipework/system components.
 - 0.2.14** Isolate the equipment/pumpset before pressure testing system. Excess pressure could irreparably damage the pressure transducer, pressure switches (where fitted) and the diaphragms of pressure vessel/hydraulic accumulators.
 - 0.2.15** It is the installers’ responsibility to ensure subsequent pipework etc can accept the pressures generated by the equipment/pumpset and to install an overpressure safety device into the system with due respect to the suction pressure present on the pumpset, the pump closed valve pressure stated on the pump, the maximum working pressure stated on any of the attached pressure vessels and any other device connected to the system e.g. boilers, calorifiers etc.
 - 0.2.16** When chlorination of the system is carried out, ensure that any residual chlorine is removed by thorough flushing as detailed in the HSE approved code of practice L8, to avoid damaging the equipment/pumpset. The normal level of chlorination is up to 2 parts per million (ppm), but shock dosing for sterilization purposes, at 25-50 ppm for 24-48 hours is acceptable as long as all chlorine is removed once the process is complete. Chlorination beyond these limits could seriously damage pumpset components and WILL NOT be covered by the warranty.
 - 0.2.17** The installer/user is responsible for the installation of the correct earthing and protection according to valid national and local standards. All operations must be carried out by a suitably qualified person.
 - 0.2.18** The equipment is only suitable for earth referenced supplies and must be permanently earthed to avoid electric shock hazard.
 - 0.2.19** The equipment must be permanently earthed with appropriate sized Earthing.
 - 0.2.20** Equipment containing variable speed drives/motors has high earth leakage current >3.5mA and will require additional earth bonding whereby a single conductor of increased size or duplicate earth conductors must be provided.
 - 0.2.21** Never perform high voltage resistance tests on control panels, variable speed drives/motors without first disconnecting the panel/drive/motor from the circuit being tested as this will damage the built in electronic components.
 - 0.2.22** Equipment containing variable speed drives/motors that has been stored/not powered up for long periods of time (i.e. 1 year or more) may require the variable speed drive/motor capacitors to be reformed. Please contact AquaTech-Pressmain for more information. Failure to reform capacitors will result in drive/motor damage.
 - 0.2.23** Metal parts (e.g. heat sinks) may reach temperatures of 90 degrees centigrade.
 - 0.2.24** RCD’s/ELCB’s are not recommended for use with variable speed drives/motors. Where their use is mandatory use type B RCD’s. For single phase equipment with inverter motors the earth leakage circuit breaker must trip out when earth fault currents with DC content (pulsating DC) occur. For three phase equipment with inverter motors the earth leakage circuit breaker must trip out when earth fault currents with DC content (pulsating DC) and smooth DC earth fault currents occur.
 - 0.2.25** RCD’s/ELCB’s suitable for use with variable speed drives/motors are not suitable for personnel protection.
 - 0.2.26** EMC – inverter motors 0.37kW to 5.5kW Electromagnetic disturbance – first environment (residential areas) – unrestricted distribution, corresponding to CISPR 11, class B, group 1. Inverter motors > 5.5kW Electromagnetic disturbance – first environment (residential areas) – restricted distribution. Immunity to Electromagnetic disturbance – second environment

(industrial areas) – unrestricted distribution, corresponding to CISPR 11, class A, group 1. Inverter motors > 5.5kW for installation in first environment (residential areas) require additional EMC filter to obtain class B, group 1 status.

- 0.2.27 EMC - With respect to BS EN61000-3-2 this equipment is defined as 'professional equipment' and therefore the installer/user may need to seek permission from the supply utility to connect this equipment to the public low voltage mains supply.
- 0.2.28 Do not use the "Pressurisation unit" for filling the system pipework. These types of equipment are only suitable for topping up small losses/leaks in the system. A separate means of filling e.g. a quick fill loop (check with local water regulations first!) should be used instead, with the system connection valve to the equipment closed.
- 0.2.29 Where "Expansion vessels" are used on LTHW heating system pressurisation units, the temperature of the fluid returning to the vessels should not exceed 70 degrees Centigrade (except where Solar vessels are used rated at 100 degrees centigrade) as this could damage the vessel diaphragm. Where the temperature exceeds 70/100C an intermediate cooling vessel should be fitted.
- 0.2.30 For MTHW and HTHW pressurisation units use a Nitrogen vessel suitable for the system conditions (or other suitable method). Please contact AquaTech-Pressmain for further information.
- 0.2.31 Do not use the "Pressurisation unit" for dosing the system with chemicals. Only allow clean cold water into the break tank. Anything other than clean cold water could damage the pumps/pipework components.
- 0.2.32 Drain cocks/valves and air bleed screws must not be left open as this could cause flooding.



0.3 CAUTIONS FOR OPERATION/USER

- 0.3.1 READ GENERAL SAFETY INFORMATION 0.0, WARNINGS 0.1 and CAUTIONS 0.2, 0.3 & 0.4
- 0.3.2 The unit should only be operated/used by a competent person; *A competent person is someone who is technically competent and familiar with safety practices and the hazards involved.*
- 0.3.3 The Owner/User of this equipment has a Legal Responsibility to ensure that it is subject to regular formal inspections. See Section 3. Servicing, for details.
- 0.3.4 Where Hydraulic Accumulator(s)/Expansion Vessel(s) are supplied as a loose item, they must be installed/connected correctly before operating the equipment, otherwise serious damage from over-pressure could occur.
- 0.3.5 The equipment must not be run until commissioned by an authorised AquaTech-Pressmain agent, this could irreparably damage the pump equipment and/or system components/pipework connected to it.
- 0.3.6 The pumpset should be left switched ON with the pumps switched to AUTO for normal operation.
- 0.3.7 The pumpset should not be left in "Hand" operation for more than 1 minute. This could lead to severe damage of pumpset components and/or pipework system from over-pressure and/or overheating.
- 0.3.8 Ensure pumpset has an adequate water supply at all times to prevent dry running causing pump seal damage and water leakage.
- 0.3.9 Do no attempt to start pumps without liquid in volutes (pumps must be fully primed); mechanical seals must have a film of liquid between faces for proper operation and to prevent damage.
- 0.3.10 The strainer located on the vacuum tube connection "A" (see Fig 1.2) must be kept clean and free of debris/dirt in order for the degassing function to work correctly.
- 0.3.11 Portable telephones or other electro-magnetic equipment must not be used near the equipment to avoid corruption of program and unpredictable operation of unit.
- 0.3.12 For Pressurisation units utilising Nitrogen Vessels (generally HTHW units) ensure there is an adequate supply of Nitrogen at all times to avoid mis-operation of the equipment.



0.4 CAUTIONS FOR MAINTENANCE

- 0.4.1 READ GENERAL SAFETY INFORMATION 0.0, WARNINGS 0.1 and CAUTIONS 0.2, 0.3 & 0.4
- 0.4.2 The unit should only be operated/maintained by a competent person; *A competent person is someone who is technically competent and familiar with safety practices and the hazards involved.*
- 0.4.3 Where the pumpset is fitted with Building Management Services (BMS) interconnections, notify the appropriate persons before switching OFF for maintenance or adjustments, to avoid unnecessary alarm conditions occurring. **WARNING:** With pumpset isolator OFF, mains voltage may still be present from BMS system. This constitutes an Electric shock hazard.
- 0.4.4 To prevent seizing, pumpsets must not be left unused for long periods (e.g. 1 week).
- 0.4.5 The pumps must be run regularly to avoid stagnation of water in the pumps/pipework (e.g. daily).
- 0.4.6 Do not vent air from air valves on vessels. These are for adjustment of pre-set cushion pressures. If wrongly adjusted this will lead to incorrect operation of the pumpset and possible damage to pumps, pipework and system components from overheating and over-pressure.
- 0.4.7 The strainer located on the vacuum tube connection "A" (see Fig 1.2) must be kept clean and free of debris/dirt in order for the degassing function to work correctly.
- 0.4.8 Switch OFF pumpset before accessing pumps and/or control panel.

1. INSTALLATION INSTRUCTIONS

1.1 GENERAL

These instructions are intended for the installer of this pressurisation unit. Please follow them carefully. The unit should only be installed by a competent person; *A competent person is someone who is technically competent and familiar with safety practices and the hazards involved.*

It should be noted that the assembly of pressure equipment on site under the responsibility of the user (or his representative) is not subject to the Pressure Equipment Directive 97/23/EC. (National legislation covering assembly on site will apply).

Failure to install the equipment as recommended below could invalidate the warranty provided by AquaTech-Pressmain to the purchaser.

1.2 ADDITIONAL WARNINGS & CAUTIONS

- 1.2.1 ON UNITS WITH VARIABLE SPEED/INVERTER DRIVES/MOTORS - DO NOT TOUCH ANY LIVE PARTS FOR AT LEAST 5 MINUTES AFTER SWITCHING OFF THE POWER. Failure to observe this will constitute an ELECTRIC SHOCK HAZARD.
- 1.2.2 READ GENERAL SAFETY INFORMATION 0.0, WARNINGS 0.1 and CAUTIONS 0.2, 0.3 & 0.4
- 1.2.3 Some larger units are supplied in multiple modular units for reconnection on site, the control/pump module, Expansion vessel(s) as loose item(s), spill tank module and cooling vessel module. Note: not all pressurisation units consist of all modules.

1.3 PROCEDURE

1.3.1 OFF-LOADING AT SITE

Do not lift unit by pipework. Lift the unit by the container pallet using a pallet/forklift or crane by passing strops underneath the skid using spreader bar. Failure to utilise these facilities could result in damage.

1.3.2 LOCATION

The pressurisation unit with degassing requires two system connections (at least 500mm apart) which should be connected to the underside of the return header on the suction side of the circulating pump, but not within any influences from the circulating pump.

If the equipment is to be installed in an unheated room, ensure that there is adequate frost protection. On a heating system do not lag any expansion vessel or its connection to the system. This can result in damage occurring.

The location of the equipment should have adequate drainage, bunding or other appropriate measures to protect assets and the building fabric in the event of leakage or water spillage. Failure to provide such measures may result in water damage to property and assets.

Ensure that location for pumpset provides adequate clear space to accommodate unit with reasonable access to all parts; AquaTech-Pressmain recommend a minimum distance of 500mm. There must be sufficient room to:-

fully open control panel door; withdraw diaphragms from vessels, repair or replace pumps. Access degassing tube on rear of unit. Access float valve in break/spill tanks, enter spill tank for maintenance/cleaning purposes.

Should any of these location conditions not be satisfied AquaTech-Pressmain reserve the right to charge labour on any warranty work required on the pumpset.

1.3.3 FIXING

Install the equipment on a flat, even and level surface, where practical on a raised plinth to keep equipment above damp floor. Locate unit in position. If necessary level the base by inserting packing strips adjacent to bolt positions. Firmly attach unit to base.

1.3.4 PIPEWORK

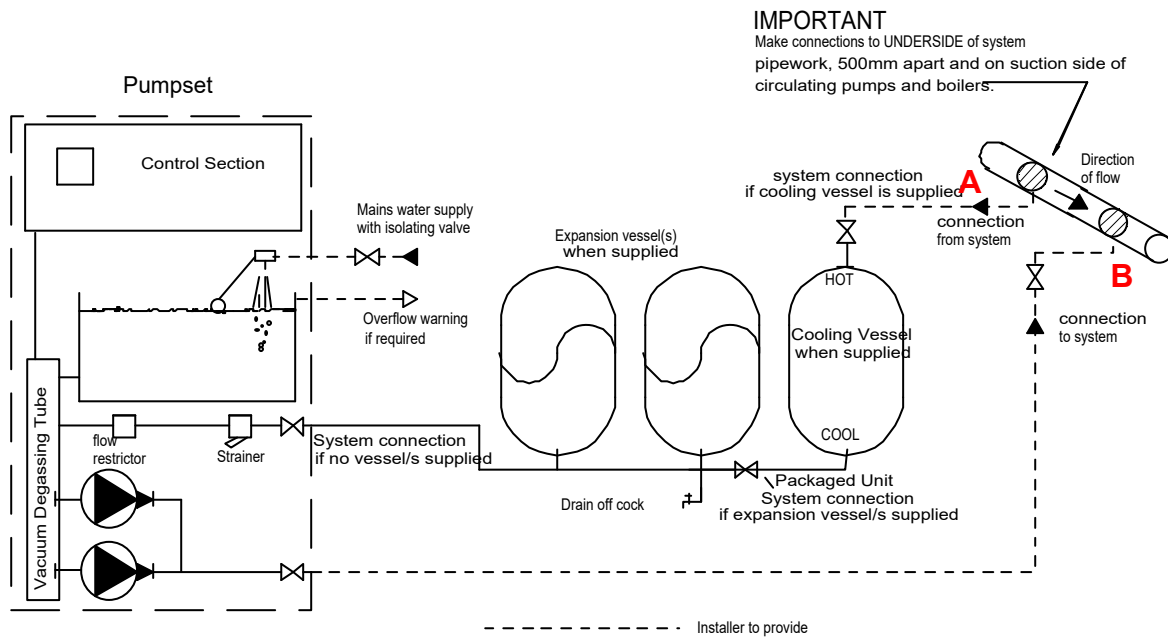

Fig 1.1 typical pipework layout for AP-DG unit

1.3.4.1 Mains Water Supply

- i. Fit an isolating valve in the supply to enable the unit to be isolated from the supply for maintenance.
- ii. Connect the supply. For Aquapack models this is a ½" BSP male connection at the side of the cabinet. For Aquaspill models ¾" BSP float valve or larger. Assemble these to suit, to provide a Type AA air gap if required, and to satisfy any local water regulations.
- iii. To maintain an adequate supply of water to the breaktank the float valve size needs to be matched to the supply pressure. The Aquapack unit is supplied with a medium pressure float valve insert (1/8" white orifice). To increase the flow fit a low-pressure insert (1/4" red orifice), available on request.
- iv. For All units the Mains water supply should be 1 bar minimum dynamic pressure.

1.3.4.2 Overflow/warning pipe

- i. Fit appropriately sized overflow/warning pipe pipework from the pressurisation unit mains water breaktank/spill tank to drain via an air break (e.g. Tundish) in a conspicuous location.

1.3.4.3 System Connection

- i. There are two connections required to the system, spaced at least 500mm apart. The upstream connection draws aerated fluid from the system to the Pressurisation/Degassing unit (via cooling vessel and expansion vessel where supplied). The downstream connection discharges degassed fluid into the system. Ensure connections are the right way round to prevent short cycling the degassed fluid.
- ii. The unit must be connected with any expansion vessels and cooling vessels, to the underside of the return header on the suction side of the circulating pumps and boiler/chiller (see Location 1.3.2.)
- iii. The system connections on the pressurisation unit should be to lockshield isolating valves.
- iv. If no expansion vessels are supplied (or vessels are supplied loose), connection "A" is at the side of the vacuum tube (see Fig 1.2), connection "B" at the discharge of pumps or for cabinet models the side of the cabinet. If expansion vessel/s are supplied "Packaged" on a base with the pressurisation unit, connection "A" is at base of the expansion vessel. If a cooling vessel is supplied, connection "A" is on the top (hot side) of the cooling vessel.

- v. All hydraulic accumulators and expansion vessels fitted to the system must have isolating and drain off valves to enable them to be serviced, as well as removable pipework to enable bladders to be changed (see fig 1.4 for examples).

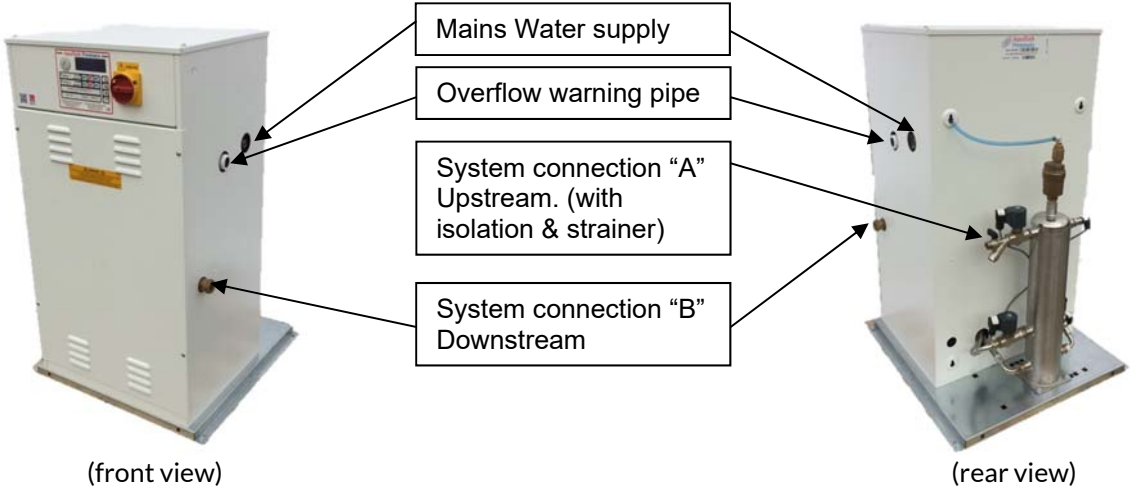

Fig 1.2 typical pipework connections for AP-DG unit

1.3.5 EXPANSION, CONTROL and HYDRAULIC ACCUMULATOR VESSELS



Fig 1.3 typical expansion vessel dimensions

Type (stockcode MTH-)	300060	300100	300200	300300	300500	700100	700200	700300	700500
Nominal Content -litres	60	100	200	300	500	100	200	300	500
D mm	409	480	634	634	740	450	485	485	600
H mm	740	840	980	1280	1485	850	1400	1965	2065
Water Connection DN BSP	1"	1"	1 ¼"	1 ¼"	1 ¼"	1"	1 ½"	1 ½"	1 ½"
Weight Kg	25	32	50	55	85	18	49	60	90
Max. working Pressure-bar	10	10	10	10	10	10	10	10	10
Max. Continuous temperature deg. C	70	70	70	70	70	100	100	100	100

All vessels must be securely mounted to prevent any movement from imposing strain on the attached pipework. Vessels of 60 litres capacity or greater **MUST** be mounted vertically on the integral legs with water connection lowermost.

Set up the vessel so the air charge filling valve (top) and the diaphragm (bottom on 70°C vessels, top on 100°C vessels) are accessible for future maintenance. All vessels must have isolating and drain off valves fitted to enable them to be serviced. The connecting pipework should be removable to give access for replacing the diaphragm and should be the same size as the vessel connection to minimise friction losses. Note: if using a flexible hose it must be suitable for the temperature of the system.

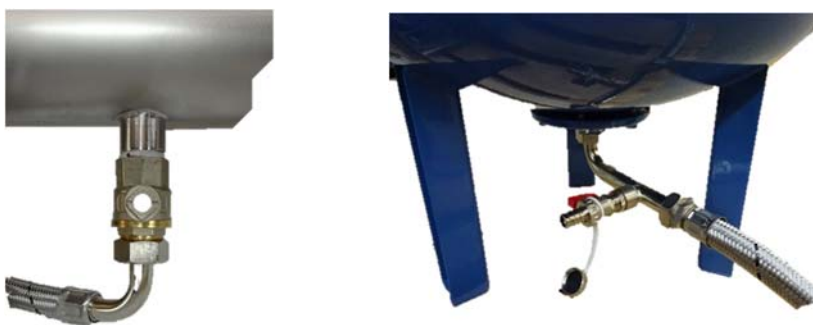

Fig. 1.4a & b Isolation valve on system pipework & Drain cock on vessel

Set the air cushion pre-charge pressure (see 2.4.2 Maintenance Procedure for details) to the correct level, dependent on the application required for the vessel. Refer to the Operating parameters at the back of this manual or Aquatech-Pressmain for advice.

Caution: If the air cushion pre-charge pressure required exceeds 4.0 Bar then you must follow the procedure shown in section 2.4 to avoid damaging/rupture of the internal diaphragm and consequences of. E.g. High and/or low pressure problems, unstable pump operation.

1.3.6 ELECTRICAL

READ GENERAL SAFETY INFORMATION 0.0, WARNINGS 0.1 and CAUTIONS 0.2, 0.3 & 0.4

- 1.3.6.1 All wiring must comply with the latest edition of local wiring Regulations.
- 1.3.6.2 **Wear anti-static wrist strap at all times** to avoid static discharge causing problems with the built in electronic program.
- 1.3.6.3 Connect incoming electrical mains supply to identified terminals in panel (see fig. 1.5). Ensure voltages and frequency indicated on the motor nameplates and wiring diagrams correspond with supply mains data and that the supply fuse ratings are correct for the total current rating of the equipment. Note: some units require a 3 Phase supply for larger applications. Refer to wiring diagram supplied with the unit or contact AquaTech-Pressmain.
- 1.3.6.4 Make any BMS connections required to terminals A-Z on Interface card inside control panel. Connect boiler/chiller terminals nos. X,Y,Z on interface card in series with the boiler/chiller control circuits so that in the event of a fault condition occurring the boiler/chillers shut down and remain inoperative until the fault condition is rectified. A typical arrangement is shown in fig 1.6.
- 1.3.6.5 Complete any required earth bonding.

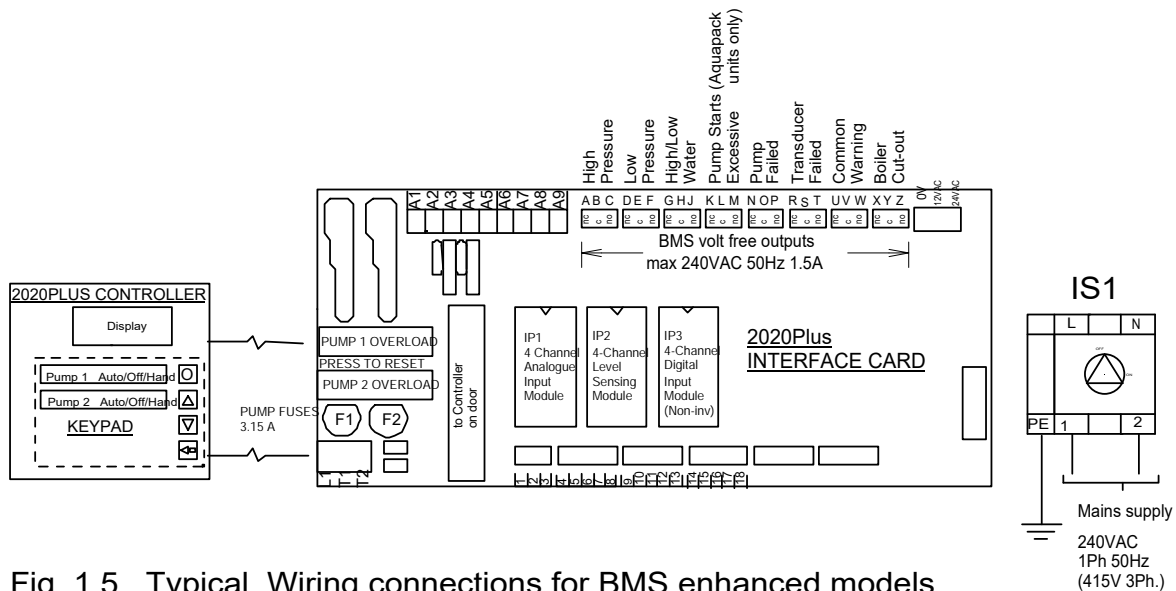

Fig. 1.5 Typical Wiring connections for BMS enhanced models

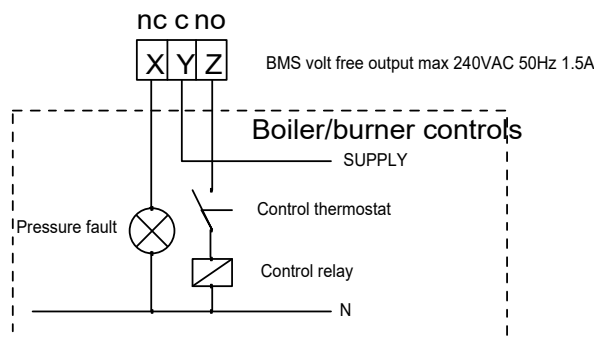

Fig 1.6 Typical Boiler Interrupt Circuit (wiring by others)

2. USER INSTRUCTIONS

2.1 CUSTOMER ASSURANCE

AQUATECH-PRESSMAIN ASSURE YOU THAT IF ANY PART OF THIS EQUIPMENT BECOMES DEFECTIVE DUE TO FAULTY MANUFACTURE OR MATERIALS WITHIN 24 MONTHS FROM THE DATE OF INVOICE, THE PART WILL BE REPAIRED OR REPLACED.

The only conditions are: -

- ◆ The equipment must have been installed, commissioned, operated and maintained as recommended by **AquaTech-Pressmain**.
- ◆ The equipment must not have been neglected, misused, modified, or used for any other purpose than its original application.
- ◆ The commissioning should be carried out within 6 months of the date of invoice by an authorised **AquaTech-Pressmain** agent.
- ◆ This Assurance does not apply to those items not supplied by us or to defects arising from parts not made or approved by **AquaTech-Pressmain**. The individual manufacturer's own policies for dealing with defects will apply.
- ◆ Any part repaired or replaced under these Assurances will be covered for the balance of the appropriate Assurance period.
- ◆ If we have any disagreement about these Assurances which we are unable to resolve we will both abide by the decision of an agreed Arbitrator or, if we are unable to agree, one appointed by the Building and Engineering Services Association (B & ES) Arbitration Scheme Rules.
- ◆ These Assurances are in addition to, and do not detract from, the contractual rights you have under Statute or at common law.
- ◆ Failure to comply with the installation, commissioning and maintenance procedures will invalidate the warranty.

For full details please see the AquaTech-Pressmain "CONDITIONS OF SALE"

2.2 COMMISSIONING

Whilst this equipment has been tested in the factory to the required settings (detailed in operating parameters at the back of instruction manual), it is impossible to simulate the actual on-site conditions, especially if they are unusual. Also, the settings may have been disturbed since leaving the factory. Therefore we strongly recommend **the equipment is commissioned by our authorised agent** who will prepare the equipment, make any necessary adjustments and leave the equipment in operational order.

Commissioning is a requirement to validate the Warranty (see Customer Assurance)

Prior to requesting an engineer to attend the site for commissioning, the client must ensure that;

- the equipment has been correctly installed;
- a written scheme of examination has been obtained where required under the Pressure Systems Safety Regulations;
- an adequate water supply and permanent electricity supply are available;
- the equipment and pipework in the building being served by the pressurisation unit is capable of accepting the generated pressures.

2.3 OPERATING INSTRUCTIONS

These units are used for maintaining the pressure in pressurised systems and are combined with Automatic Degassing of the system water.

Aquapack units: sealed heating systems up to 30,000L and chilled systems up to 200,000L.

READ GENERAL SAFETY INFORMATION 0.0, WARNINGS 0.1 and CAUTIONS 0.2, 0.3 & 0.4

2.3.1 ADDITIONAL WARNINGS & CAUTIONS

ON UNITS WITH VARIABLE SPEED/INVERTER DRIVES/MOTORS - DO NOT TOUCH ANY LIVE PARTS FOR AT LEAST 5 MINUTES AFTER SWITCHING OFF THE POWER. Failure to observe this will constitute an ELECTRIC SHOCK HAZARD.

- 2.3.1.1 Isolate the pressurisation unit from the system before pressure testing** to avoid possible damage to transducer and expansion vessels.
- 2.3.1.2** The strainer located on the vacuum tube connection "A" (see Fig 1.2) must be kept clean and free of debris/dirt in order for the degassing function to work correctly.

2.3.2 NORMAL OPERATION

The **pressurisation unit** automatically maintains a minimum set pressure in a heating or chilled system by transferring make-up liquid from a breaktank, spilltank or sealed spill vessel into the system. When the system pressure falls below the required level the Duty pump automatically refills the system until the pressure is restored. If the Duty Pump fails to maintain the required pressure the Support pump will operate in addition to the Duty Pump.

The **Degassing section** of the unit draws system water into the degassing tube via a strainer and restriction. The strainer must be kept clean. The pressurisation pumps operate to produce a vacuum within the tube which liberates air from the water. When the pumps stop running the tube is refilled with more system water and the air is expelled via the air vent on top of the tube. The process is repeated at pre-programmed intervals. E.g. when first commissioned (or after reset) every 3 minutes for 5 hours, then every hour for 2 days and finally once every day until switched off.

2.3.2.1 The **Pressurisation unit section** control is by AquaTech-Pressmain 2020Plus Microprocessor, with a 2-line display on the control panel, showing the current system pressure and status.

When switched on the display shows, then self-checks, flashing all LED lights on keypad, and identifies configuration for pump operation (e.g. "AquaPack" pressurisation unit)

AQUATECH 2020Plus V5.00
PRESSMAIN

AquaPack

followed by the system status and pressure

PRESSURE SYSTEM IS O.K.
Pressure bar

2.3.2.2 The **Degassing section** control is by AquaTech-Pressmain Smart Relay controller (inside the controls section of the pressurisation unit – under the top lid), with a 6-line display showing the current system status, system pressure and vacuum tube pressure.

When switched on, the display shows an alarm free condition like this > (screens shown are examples only, and may vary depending on unit type)

Time until next
Degas can start=
5:00m Pwr Up Count
+1.00m Min Count
+0.00m Hour Count
+0.00h Daily Count

Note: in order to make the display more visible, you can toggle the backlight permanently on or off by pressing the <ESC> and <UP> buttons together.

Press the <DOWN> arrow to display information such as : - (screens shown are examples only, and may vary depending on unit type)

SYS PRESSURE =
+2.5 Bar
TUBE PRESSURE =
+2.5 Bar
Degassing cycles
Completed = 523

Press the <DOWN> arrow to display information such as : - (screens shown are examples only, and may vary depending on unit type)

Power Up = 1587 h
LP Alarm = +0.0 Bar
HP Alarm = +8.0 Bar
Pump 1 on= 28 hours
Pump 2 on= 28 hours
Initial Degas = 100

Press the <DOWN> arrow to display clock (display might be showing I=inputs, Q=outputs, AI=analogue inputs, AQ=analogue outputs, M=markers or ESC+C= escape button+cursor) : - (screens shown are examples only, and may vary depending on unit type)

Tue 12:51
2016-06-14

2.3.2.3 For "normal" operation, all Hand/Off/Auto switches should be left in "Auto", all pump suction and discharge valves should be left open, all hydraulic accumulator/expansion vessel isolating valves should be left open, and drain cock/valves should be left closed. Should it be necessary to have a situation that is not "normal" operation, then we would strongly recommend attendance to site by our trained/authorised service personnel. Please contact AquaTech-Pressmain for more details.

2.3.2.4 Pump Operation

i) Sealed system pressurisation unit; “AP” Models:

The pressurisation unit automatically maintains a minimum set pressure in a heating or chilled system by transferring make-up liquid from a breaktank, into the system. When the system pressure falls below the required level the Duty pump automatically refills the system until the pressure is restored. If the Duty Pump fails to maintain the required pressure the Support pump(s) will operate in addition to the Duty Pump.

ii) Heating system pressurisation unit; SpillBack “SB3, SB7 & AquaSpill ASxAV” Models: (where “x” is the number of pumps)

Operation as for “AP” units above except these units are for larger systems have a spill valve(s) which opens at a predetermined pressure whilst water is expanding and raising the pressure in the control vessel. Once opened the spill valve(s) allows water to pass into the sealed spill vessel(s) or spilltank(s). The system pressure falls until it reaches the cut-off point of the spill valve(s). This operation continues during the period of raising the system temperature. During a fall in the system temperature the contents contract and allow the system pressure to fall. The system pressure is made up by the Duty pump returning water to the system from the sealed spill vessel(s) or spilltank(s). In the event of insufficient water being available in the spill vessel/spilltank, which can normally be attributed to losses from the system, the pump will draw water from the breaktank, or the spilltank will refill. All units have fixed speed pumps except “ASxAV” units which have variable speed pumps for precise pressure control.

2.3.2.5 Duty Pump Rotation.

To spread the wear evenly across all the pumps, their sequence is automatically rotated either by starting the pump that has been idle the longest and/or by timed operation (dependent upon unit type). Indicator lights (where fitted) on the fascia show which pump is running.

2.3.2.6 Automatic Restart (when “manual restart” is set to “not enabled” on 2020 Plus controller)

If there is an interruption to the electrical supply the unit will automatically restart on restoration of the supply. Pumps will restart at timed intervals and at reduced speed dependent upon model type.

2.3.2.7 Manual Restart (when set to “enabled” on 2020 Plus controller)

If there is an interruption to the electrical supply, or there is a low water level condition, the unit will need to be manually reset on restoration of the supply, or low water level condition, by pressing the “Reset Alarm” key. Pumps will then restart at timed intervals and at reduced speed dependent upon model type.

2.3.2.8 Pressure setting. The pumpset is set at the required 'duty' pressure at the factory. If necessary, the pressure will be adjusted at commissioning to suit local conditions.

2.3.2.9 To view the pressurisation unit section parameters

Press <SET/VIEW> on the keypad.

Press the <UP> (7) key, to view the next parameter.

Page through the parameters by using the <UP> (7) and <DOWN> (8) keys to view:

Various parameters will be displayed dependent upon unit type. The main parameters that customers are interested in are shown on the following page (displays are dependent upon unit type).

Date and Time (24 hour clock)

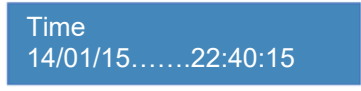

not password protected to allow on site adjustment.

Fault Log (last 30 faults)

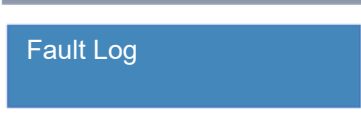

press <view> to see log followed by <up> (7) or <down> (8) to view log. press <enter> to return

Manual Restart upon power failure or low water level condition

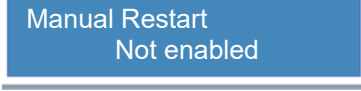

not password protected to allow user to enable/disable

Set Tanks enabled

not password protected to allow user to enable/disable break tank Low level & High level alarms for cleaning etc.

Pumps 1 & 2 hours run time

Pump x run time
000123.4 Hours

Spill valve count

Spill valve count
521

number of spill valve operations

Time elapsed since last service

Since last service
000987.6 Hours

service reminder after 6 months

Total run time (power up time)

Total run time
005000.0 Hours

not resetable

Enable service call

Enable service call
Enabled

enable/disable service reminder

Low pressure Lockout

LP Lockout
Not Active

pump dry run/over-run protection

Low pressure alarm

Low pressure
1.0 Bar

low pressure alarm. Note: low pressure approach warning is 0.2 bar more than this value

Low pressure delay

Low p delay
10 sec

time before alarm is initiated.

High pressure alarm

High pressure
8.0 Bar

high pressure alarm. Note: high pressure approach warning is 0.2 bar below this value

High pressure delay

High p delay
10 sec

time before alarm is initiated.

Duty delay

Duty delay
0 sec

to delay duty pump starting to circulator pump pressure dips

Support delay

Support delay
10 sec

to delay support pump starting in normal operation preventing electrical/pressure dips/surges

Starts in 12 minutes

Starts/12 mns
0

sets frequency of pump starts warning (system leak detection)

Duty pressure	Duty pressure 3.0 bar	Duty pump cut-out pressure. All other pumps are derived from this value.
Minimum run time	Min run time 3 sec	for each pump
Maximum number of pumps to run	Max pumps to run 8	limits number of pumps allowed to run simultaneously (and therefore number of standbys)
Spill ON pressure	Spill ON offset 5.0 Bar	Spill valve open (when fitted)
Spill ON/OFF differential	Spill differential 0.2 Bar	Spill valve close (below ON)
Spill staging between valves	Spill staging 0.3 Bar	Inter-Spill valve staging (when multiple valves fitted)

2.3.2.10 To view the Degassing section controller

When switched on, the display shows an alarm free condition like this > (screens shown are examples only, and may vary depending on unit type)

Time until next
Degas can start=
5:00m Pwr Up Count
+1.00m Min Count
+0.00m Hour Count
+0.00h Daily Count

When the degassing sequence is in progress, the display shows > (screens shown are examples only, and may vary depending on unit type)

DeGas No. 12345
In Progress
System Pressure =
2.0 Bar
Tube Pressure
= -1.0 Bar

To RESET the degassing sequence for (re)commissioning system > Press the <ESC> and <right arrow> together. The Degassing Sequence resets to the beginning, e.g. degas every 3 minutes for 5 hours, then every hour for 2 days, then once every day.

DeGas No. 12345
In Progress
System Pressure =
2.0 Bar
Tube Pressure
= -1.0 Bar

If an Alarm condition is present, the display shows >

Followed by the alarm condition(s) present

SYSTEM ALARM
Info Follows
System Pressure =
2.0 Bar
Tube Pressure
= 2.0 Bar

2.3.3 SYSTEM WARNINGS

Flashing display giving type of fault and a common warning volt free output signal on BMS enhanced models

**** Warning ****	Cause	Check
High pressure approach	system pressure at high pressure setting minus 0.2 Bar	Pressure vessel air charge wrong? Or insufficient expansion capacity?
Low pressure approach	system pressure at low pressure setting plus 0.2 Bar	Pressure vessel air charge wrong? Or water usage exceeds design capacity?
Pump starts exceeded/is system leaking?	duty pump starts exceeded "starts in 12 mins" parameter	System pipework is leaking excessively? Starts parameter set too low?
Excessive run time/ is system leaking?	duty pump continuously running for 12 minutes	System pipework is leaking excessively?
Commissioning needed	Unit has not been commissioned by authorised service engineer	Have unit commissioned by authorised service engineer.
Tank 1 Disabled	Tank 1 alarms have been disabled using controller keypad	Tank 1 alarms disabled for tank cleaning? Re-enable alarms when finished.
Tank 2 Disabled	Tank 2 alarms have been disabled using controller keypad	Tank 2 alarms disabled for tank cleaning? Re-enable alarms when finished.
Power Up	Power interruption started "Power Up" sequence	Incoming electrical supply interruption? Or missing phase? Or loose connections?
Low level delay	A low water level condition has reset, and a 4 minute delay is now initiated before normal operation will resume	Check pumps are vented and wait for the delay time to expire
Manual restart (when set to enabled)	A power interruption or low water level has occurred,	Carry out all necessary checks, then press the "Reset alarm" key on the micro

2.3.4 SYSTEM ALARMS

Flashing display giving type of fault, audible alarm, volt-free output signals on BMS Enhanced models, and action as described. (see below)

RESET: Alarms are manually muted and reset using the UP (7) or DOWN (8) buttons on the keypad. (Automatic reset facility can be provided)

**** Alarm ****	Cause	Check
Pressure system Fault	Check pumps 1 to 4, or 5 to 8 for a pump-tripped condition. (by pressing <Enter> key)	Check electrical supply is within tolerance, or missing phase? Pump seized? motor failed? Variable speed drive/inverter trip? Motor thermistor overheated?
High pressure	system pressure at/above high pressure setting & delay timer expired	Pressure vessel air charge wrong? Or insufficient expansion capacity? Pump(s) left in Hand?
Low pressure	system pressure at/below low pressure setting & delay timer expired	Pressure vessel air charge wrong? Or water usage exceeds design capacity? Pump(s) switched Off or Tripped?
Transducer failed	Pressure sensor output above normal range of pressure sensor or pressure sensor not connected correctly.	Pressure higher than sensor range? Or pressure sensor failed? Or pressure sensor wiring loose?
Pump overload fault	Pump/Inverter tripped signal present	Check electrical supply is within tolerance, or missing phase? Pump seized? motor failed? Motor thermistor overheated?
No water in feed tank	water level below supply tank low water alarm probe or pipework sensor dry. (240 second delay on automatic restart, after restoration of water level).	Break tank float valve stuck closed? Or output of pumpset exceeds mains water supply into break tank? Mains water interruption to break tank?
Pump overheated	Pump motor temperature too high.	Pump seized? motor failed? Motor thermistor overheated?
High water level Tank 1 or 2	water level above supply tank high water alarm probe	Break tank float valve wrongly adjusted, stuck open or letting by?
Low pressure lockout/ please vent the pumps	system pressure remained at or below low pressure setting for duration of low pressure delay timer, and lock out protection is invoked.	Pumps are air locked and need venting? Or running off end of curve due to demand beyond design limit? Pump(s) switched Off or Tripped?
Low water level Tank 1 or 2	water level below supply tank low water alarm probe or pipework sensor dry. (240 second delay on automatic restart, after restoration of water level).	Break tank float valve stuck closed? Or output of pumpset exceeds mains water supply into break tank? Mains water interruption to break tank?
Leak Detect Lock-out Pumps disabled.	Leak Detect Lockout has been enabled and Pump starts exceeded or Excessive run time has activated.	System pipework is leaking excessively? Starts parameter set too low?
Other Fault	Hardware shutdown	Please call AquaTech-Pressmain for advice

If a problem persists contact AQUATECH-PRESSMAIN quoting the serial number WN/SO:_____ (on control panel fascia)

2.3.5 REMOTE SIGNALS on BMS Enhanced models only

- volt free contacts in control panel (see fig 1.5) :

High system pressure, Pump tripped/failed, Low system pressure, Transducer failed, High/Low Water level in breaktank, Common warning, Excessive pump starts (Aquapack units only), Boiler/chiller cut-out

2.3.6 RESETTING PARAMETERS

The parameters can be protected from inadvertent alteration by a password security code. The factory default is for no password protection to be enabled. This can be changed to password protected if required.

Parameters may be reset on site by a user or an Aquatech-Pressmain Service engineer.

2.3.7 SERVICING REMINDER

When routine service is due display gives telephone no. to call

This can be deactivated if required.

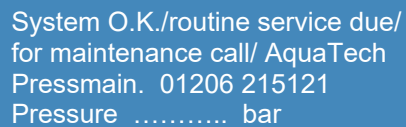

System O.K./routine service due/
for maintenance call/ AquaTech
Pressmain. 01206 215121
Pressure bar

2.4 MAINTENANCE INSTRUCTIONS

READ GENERAL SAFETY INFORMATION 0.0, WARNINGS 0.1 and CAUTIONS 0.2, 0.3 & 0.4

2.4.1 PROCEDURE

The strainer located on the vacuum tube connection “A” (see Fig 1.2) must be kept clean and free of debris/dirt in order for the degassing function to work correctly.

Every 6 months the unit should be maintained by authorised AquaTech-Pressmain service agents -see Servicing (Section 3)

Pump Lubrication

The pumps require no lubrication, as the pumps are self-lubricating. Motor bearings for 0.37 to 7.5kW motors are normally sealed and require no lubrication.

Expansion, Control and Hydro Accumulator vessels

Air Charge Pressure. The correct charge pressure provides reliable operation of the system and a prolonged lifetime of the diaphragm. This should be checked regularly. Caution: If the air cushion pre-charge pressure required exceeds 4.0 Bar then you must follow the procedure shown below to avoid damaging/rupture of the internal diaphragm and consequences of. E.g. High and/or low pressure problems, unstable pump operation.

- To adjust air charge pressure < 4.0Bar:** isolate the vessel from the system and release pressure on water side by opening the drain cock disposing of the water-mix in the appropriate manner. The water inside the bladder will be pushed back by the air charge pressure. Remove cap on the filling valve, set air charge pressure refilling using dry air or nitrogen. Screw cap firmly on filling valve. Close the drain cock and slowly open water connection to the system.
- To adjust air charge pressure > 4.0Bar:** If vessel is already in use then isolate hydraulically, reduce the air charge to 4.0Bar then evacuate the water side of the vessel followed by evacuation of the air side. With the vessel empty of water and air, set the air charge pressure (using dry air or nitrogen) to 4.0Bar, bring the water side pressure up to 5.0Bar and close isolating valve, then add more air until the air side pressure is equal to the required pre-charge pressure multiplied by 1.2 e.g. for a pre-charge pressure of 6.0Bar after filling vessel with air to 4.0Bar followed by water to 5.0Bar, fill the air side to $6.0 \times 1.2 = 7.2$ Bar. Screw cap firmly on filling valve and slowly open isolating valve & water connection to the system.

**LEAVE EQUIPMENT WITH ALL PUMPS SWITCHES IN THE AUTO POSITION,
THE MAINS SUPPLY SWITCHED ON AND THE SYSTEM CONNECTION OPEN.**

3. SERVICING

3.1 MAINTENANCE AND CARE OF YOUR EQUIPMENT

The AquaTech-Pressmain equipment that is described in this instruction booklet has been manufactured and tested to the highest standards of design and quality. It will give trouble free operation over many years provided it is maintained regularly from when it is commissioned. To keep it operating efficiently in a safe, economical and environmentally friendly condition, regular maintenance is an essential part. AquaTech-Pressmain along with its' service division, Acorn Pressurisation Services are the official providers of commissioning and maintenance services. (see below).

Several companies operating under the Aquatronic Group Management structure are available to fulfil a wide range of servicing and maintenance requirements, as detailed below.

3.2 LEGAL REQUIREMENTS

Hydraulic Accumulators/Expansion Vessels installed as part of/in conjunction with this equipment, with Pressure x Volume above 250 Bar-litres, require formal inspection in accordance with a "Written Scheme of Examination". This is a Legal Requirement on the part of the Owner/User under the "Pressure Systems Safety Regulations" (PSSR). A "Written Scheme" and regular inspection can be provided by either Acorn Pressurisation Services (combined maintenance and inspection) or ESIS Ltd (inspection only), see details below.



Plant Servicing & Inspection
ACORN PRESSURISATION SERVICES,
 AGM House, London Rd, Copford, Colchester Essex, CO6 1GT.

Ph: 01206 215151

10 Wheel Forge Way, Manchester. M17 1EH. Ph: 0161 226 4727

Acorn provides maintenance and installation of all types of packaged water pumping equipment for building services. Its specialist fields are Pressure booster equipment and sealed systems for heating and chilled water distribution systems.

Regular servicing of any plant for essential services is vital because wear and tear are very gradual processes. With preventative maintenance, the costs are small and benefits in reliability, safety and economy can be significant. Acorn Pressurisation Services can provide a complete package of schemes for preventative maintenance on all AquaTech-Pressmain and other makes of equipment.



Pressure Vessel Inspection
ESIS ENGINEERING SAFETY & INSPECTION SERVICES LTD,
 AGM House, London Rd, Copford, Colchester, Essex, CO6 1GT.
Phone: 01206 215141

Under the Pressure Systems Safety Regulations, expansion vessels and hydraulic accumulators, generally 250 bar-litres and greater, and protection devices, require a Written Scheme of Examination before they can be operated. ESIS Inspection and Insurance Services Limited specifications can provide the means to comply with these regulations. These services can be extended to cover other units e.g. air pressure receivers etc.

3.3 SERVICE CONTACTS

For service during warranty period contact: AQUATECH-PRESSMAIN Service Department

Head Office Tel: 01206 215121

For regular servicing, contact service division: ACORN PRESSURISATION SERVICES

Head Office Tel: 01206 215151 Manchester Office Tel: 0161 226 4727

who will be pleased to give you expert advice on this or any other servicing matter.

4. DISPOSAL

Disposal of this product or parts of it must be carried out in accordance with the following guidelines:

- 4.1 Use the local public or private recycling/waste collection service.
- 4.2 In case such a recycling/waste collection service does not exist or cannot handle the materials used in this product, please deliver the product or any hazardous material from it to your nearest AquaTech-Pressmain office.

EU Declaration of Conformity

We, Aquatronic Group Management Plc, declare that the equipment detailed below:

**PRESSURISATION UNITS
ACCORDING TO DRAWING;**

A12290a

Complies with the requirements of the following European Directives:

Pressure Equipment Directive 2014/68/EU (PED)

Machinery Directive 2006/42/EC

Low Voltage Directive 2014/35/EU

Electro Magnetic Compatibility Directive 2014/30/EU

PED Conformity Assessment Modules

Module B : Certificate No. CE 641230

Module D : Certificate No. CE 641231

Notified Body conducting the Conformity Assessment:

BSI Group The Netherlands B.V.

Say Building

John M. Keynesplein 9

1066 EP

Amsterdam

Netherlands

Notified Body No. 2797



1/1/2021

I.D.Taylor, I.Eng. MIET, Director

Aquatronic Group Management Plc

T/A AquaTech-Pressmain

AGM House, London Rd, Copford, Colchester, Essex CO6 1GT UK

Telephone: 01206 215121

Please note: it is possible for the control panel only or pump unit only to have been sold as a separate item, in which case the O&M manual and CE declaration may only be applicable in part.

OPERATING PARAMETERS

SERIAL No. **MODEL**

THE SERIAL & MODEL NUMBERS MUST BE QUOTED WHEN REQUESTING ASSISTANCE

ELECTRICAL DATA:

Supply volts Ph Hz
Full load current of pumpset Amps
Max. unit loading: Kw Method of starting:

NOISE LEVEL: less than 70 db(A) unless otherwise stated

PRESSURE SETTINGS:

AS FACTORY SET

bar secs
Duty pressure (cold fill) Duty pump delay
Support pump cut-in Support pump delay
High Pressure High pressure delay
Low pressure Low pressure delay
Spill valve cut-in pressure
Expansion vessel cushion pressure.
Control vessel cushion pressure

❖ AMENDED AT COMMISSIONING	
bar	secs
.....
.....
.....
.....
.....
.....
.....

❖ On commissioning it may be found necessary to modify these settings. Providing this information is left with the equipment, the figures will be updated by the commissioning engineer.

Updated by commissioning engineer Date