

INSTRUCTIONS FOR

0. GENERAL SAFETY INFORMATION, WARNINGS & CAUTIONS
1. INSTALLATION
2. THE USER
3. SERVICING
4. DISPOSAL

ESL BOOSTER SETS

COLD WATER PRESSURE BOOSTER SERIES



ISSUE 3 17/4/18

Head Office: AGM House, London Rd, Copford, Colchester, Essex CO6 1GT UK
Tel: 01206 215121 Email: aftersales@agm-plc.co.uk

Manchester Office : Unit 10, Wheel Forge Way, Ashburton Road West, Manchester. M17 1EH
Tel: 0161 226 4727 Email: aftersales@agm-plc.co.uk

PRODUCT IDENTIFICATION

All units described in this manual are used to automatically increase and maintain the water supply pressure to a preset 'Duty' pressure.

Please note that the Serial Number "SO:xxxxx" or "WNxxxxx" and model reference will be visible on a label and on the back page of the manual supplied with the unit.

Examples of units manufactured by Aquatech Pressmain are shown below: -

Please note: it is also possible for the components to have been sold as a separate items, in which case the O&M manual and CE declaration may only be applicable in part.



ESL mini - APT65
Single pump Variable speed
booster set with 65 litre mains
breaktank

ESL mini - APT225
Single pump Variable speed
booster set with 225 litre
mains water breaktank

ESL twin - APT700
Twin pump Variable speed
booster set with 700 litre mains water
mains water breaktank

CONTENTS

PRODUCT IDENTIFICATION		2
CONTENTS		2
0. GENERAL SAFETY INFORMATION		4
0.1 WARNINGS		4
0.2 CAUTIONS FOR INSTALLATION		6
0.3 CAUTIONS FOR OPERATION/USER		8



0.4	CAUTIONS FOR MAINTENANCE.....	9
1.	INSTALLATION INSTRUCTIONS.....	10
1.1	ADDITIONAL WARNINGS.....	10
1.2	ADDITIONAL CAUTIONS.....	10
1.3	PROCEDURE.....	10
1.3.1	OFF-LOADING AT SITE.....	10
1.3.2	LOCATION.....	10
1.3.3	FIXING.....	10
1.3.4	PIPEWORK.....	11
1.3.5	PUMP DETAILS.....	12
1.3.6	FLOW THROUGH VESSELS (when supplied).....	12
1.3.7	ELECTRICAL.....	13
1.3.8	GUIDANCE ON SELECTING THE CORRECT EARTH LEAKAGE PROTECTION DEVICE FOR BOOSTER SETS.....	13
2.	USER INSTRUCTIONS.....	13
2.1	CUSTOMER ASSURANCE.....	13
2.2	COMMISSIONING.....	14
2.3	OPERATING INSTRUCTIONS.....	14
2.3.1	ADDITIONAL WARNINGS.....	14
2.3.2	ADDITIONAL CAUTIONS.....	14
2.3.3	NORMAL OPERATION.....	14
2.3.4	SYSTEM ALARMS.....	16
2.3.5	PRIMING/VENTING PUMPS.....	17
2.4	MAINTENANCE INSTRUCTIONS.....	17
2.4.1	ADDITIONAL CAUTIONS.....	17
2.4.2	PROCEDURE.....	17
3.	SERVICING.....	18
3.1	MAINTENANCE AND CARE OF YOUR EQUIPMENT.....	18
3.2	LEGAL REQUIREMENTS.....	18
3.3	SERVICE CONTACTS.....	18
4.	DISPOSAL.....	19
	EC DECLARATION OF CONFORMITY.....	19
	OPERATING PARAMETERS.....	20



0. GENERAL SAFETY INFORMATION



- These instructions are intended for the installer/operator/user/maintenance of this equipment and must be kept with the equipment, for the life of the equipment and made available to all persons. Please read GENERAL SAFETY INFORMATION 0.0, WARNINGS 0.1 and CAUTIONS 0.2, 0.3 & 0.4 before doing anything else, and then follow them carefully.
- The unit must only be installed/operated/used/maintained by a competent person; *A competent person is someone who is technically competent and familiar with safety practices and the hazards involved.*
- Hydraulic Accumulators/Expansion Vessels installed as part of/in conjunction with this equipment, with Pressure x Volume above 250 Bar-litres, require regular formal inspection by a *competent person*. This is a Legal Requirement under the “Pressure Systems Safety Regulations” (PSSR) and the Owner/User should be made aware of their responsibility for this. (see section 3. Servicing).
- Failure to install/operate/use/maintain the equipment as recommended below could cause damage to the equipment any anything subsequently connected to it, and invalidate the warranty provided by AquaTech-Pressmain to the buyer.
- Any damage caused to the equipment by misapplication, mishandling or misuse could lead to risk of **Electrocution, Burns, Fire, Flooding or injury to people or property** dependent upon the circumstances involved.
- This equipment contains moving/rotating parts that must remain guarded. Removal of or missing guards could lead to serious personal injury.
- This equipment automatically restarts after a power interruption.
- We accept no responsibility or liability for any consequences or damage/losses due to misapplication, mishandling or misuse of the equipment.
- It should be noted that the assembly of pressure equipment on site under the responsibility of the user (or his representative) is not subject to the Pressure Equipment Directive 97/23/EC. (National legislation covering assembly on site will apply)
- Water storage tanks contain water and as such represent a risk of injury or death as a result of drowning and/or flooding and/or injury or death as a result of structural failure of the tank.
- The latest version of this instruction manual with up to date safety information can be downloaded from our website at www.aquatechpressmain.co.uk



0.1 WARNINGS

- 0.1.1 Do not touch any live parts for at least 5 minutes after switching off the electricity supply. Failure to observe this will constitute a severe Electric shock and/or Burns hazard and may be lethal.
- 0.1.2 The equipment is only suitable for earth referenced supplies and must be permanently earthed to avoid Electric shock hazard.
- 0.1.3 With equipment isolator OFF, mains voltage may still be present from BMS system. This constitutes an Electric shock hazard.
- 0.1.4 Emergency stop button does not remove dangerous voltages from control panel/pump motor assemblies. This constitutes an Electric shock hazard.
- 0.1.5 Metal parts (e.g. heat sinks) may reach temperatures of 90 degrees centigrade and will constitute a Burns hazard.
- 0.1.6 Some equipment is designed to operate with liquid temperatures up to 150 degrees centigrade and will constitute a Burns/scalding hazard.
- 0.1.7 The equipment must not be pressurised beyond the maximum working pressure as stated on pumps/pipework/vessels/control panel otherwise serious mechanical damage/destruction could occur causing injury to people or property.

-
- 0.1.8 The equipment must not be heated/chilled beyond the maximum/minimum working temperature as stated on pumps/pipework/vessels/control panel otherwise serious mechanical damage/destruction could occur causing injury to people or property.
 - 0.1.9 Any damage to equipment, pumpset, vessels, pipework or system components caused by misapplication, mishandling or misuse could lead to Electric shock hazard, Burns hazard, Fire hazard, Flooding hazard or cause injury to people or property.
 - 0.1.10 This equipment may contain moving/rotating parts that must remain guarded. Removal of or missing guards could lead to serious personal injury.
 - 0.1.11 Pressure vessels must never be disassembled whilst in use, they contain high pressure air/gas charge which could cause injury to people or property.
 - 0.1.12 Pump motors with lifting eyes; the lifting eyes are only suitable for lifting motors NOT the entire pump assembly. This could cause injury to people or property.
 - 0.1.13 Ensure the base/foundation/plinth/wall to which the equipment is to be attached is sufficiently strong enough to carry the entire mass of the equipment including the water that it will contain under worst-case fault conditions. E.g. fully saturated pressure vessel with no air charge, break tank full to overflowing, etc. Failure to observe this could cause serious mechanical damage/destruction resulting in injury to people or property.
 - 0.1.14 This equipment contains a fluid which may under certain circumstances leak/drip/spray fluid (e.g. servicing, repair or malfunction). Ensure any fluid discharge will not cause damage to the surroundings by taking appropriate action. E.g. install in a place that will not be damaged by leakage or install in a bunded area with adequate drainage.
 - 0.1.15 Neither the tank nor upstand (if supplied) are suitable for use as a working platform or designed to support the weight of man traffic. Standing on, walking across, and/or use of the tank as a support may result in death or serious injury and/or structural failure of the tank resulting in serious damage to equipment and/or property.
 - 0.1.16 It is essential that the tank is correctly connected to all incoming, outgoing, drain and overflow and/or any other related pipework and/or electrical equipment of any kind before the tank is filled. Failure to do so may result in death or serious injury and/or structural failure of the tank resulting in serious damage to equipment and/or property.
 - 0.1.17 Do not remove the main lid of the tank without first draining the tank. The lid is a structural part of the tank and MUST remain correctly fitted and fixed down at all times whether water is contained within the tank, or whether the tank is empty. Removal of the main lid of the tank when water is contained within the tank may result in death or serious injury and/or structural failure of the tank resulting in serious damage to equipment and/or property.
 - 0.1.18 AquaTech Pressmain storage tanks are designed to operate at atmospheric pressure only and must not be pressurised or be subjected to vacuum. Should any tank be subjected to pressurisation and/or vacuum this may result in death or serious injury and/or structural failure of the tank resulting in serious damage to equipment and/or property.
 - 0.1.19 AquaTech Pressmain tanks are designed to operate within a specific temperature range between 3°C & 30°C. UNLESS SPECIFICALLY STATED OTHERWISE the temperature of the tank and/or water contained within must not fall below 3°C or exceed 30°C. Should such a condition arise this may result in structural failure of the tank resulting in death or serious injury and/or serious damage to equipment and/or property.
 - 0.1.20 AquaTech Pressmain tanks are designed to contain clean, wholesome water only, and are not suitable to be in contact with water containing additives of any kind other than those included by any local water authority for the purposes of maintaining water hygiene and within standards and to concentrations allowing such water to remain as of a potable standard, being fit for drinking purposes.
 - 0.1.21 Chlorination of the tank should take place using only chemicals and materials which are deemed suitable for use in contact with GRP tanks. Chemicals must be at concentrations which will not cause damage to the tank. Contact time for such materials should be no more than 1 hour duration and should be thoroughly flushed from the tank after use. Any unsuitable abrasive or aggressive chemical products and/or materials may cause damage to the structure of the tank.



0.2 CAUTIONS FOR INSTALLATION

- 0.2.1** READ GENERAL SAFETY INFORMATION 0.0, WARNINGS 0.1 and CAUTIONS 0.2, 0.3 & 0.4
- 0.2.2** The unit should only be installed/operated by a competent person; *A competent person is someone who is technically competent and familiar with safety practices and the hazards involved.*
- 0.2.3** Do not lift the pumpset by pipework. Lift the pumpset by the container pallet using a pallet/forklift or crane by passing strops underneath the skid using a spreader bar. Failure to utilise these facilities will result in damage to the pumpset.
- 0.2.4** Store in a dry place to avoid damp conditions deteriorating the equipment.
- 0.2.5** Protect against dirt, damage and frost. It is absolutely essential that no foreign matter such as pipe thread swarf, welding slag, grit or stones are allowed to enter the set. Debris of this type can cause severe damage to the mechanical seals, diaphragms and impeller. Frost/freezing will damage pumps/pipework and control panel components.
- 0.2.6** The equipment is only suitable for installation in a clean, dust free indoor environment, with adequate protection from heat and frost, and sufficient ventilation to ensure cooling of the motors. Ambient air temperature should be between 5 and 40 degrees centigrade, non-condensating. Operation outside of these conditions could seriously damage the equipment.
- 0.2.7** If the equipment were to be stored or taken out of service for a period of time (e.g. 1 week or more), then we would recommend draining the equipment of all water/liquid (with due regard to any local regulations) to prevent frost damage to components. When restarting is required we would recommend commissioning by our authorised service agent.
- 0.2.8** Ensure the base/foundation/plinth/wall to which the equipment is to be attached has sufficient mass compared to the equipment, in order to avoid noise/vibration transmission. E.g. the mass of the base should be at least five times the mass of the equipment.
- 0.2.9** Ensure the electrical supply is the correct voltage, current, frequency and type for the equipment supplied and that suitable circuit protection equipment is installed in the supply. Incorrect electrical installation could be an electric shock/burns/fire hazard.
- 0.2.10** When accessing the control panel to make electrical connections adopt anti-static procedures e.g. wear anti-static earthed wristband, to avoid risk of damaging the controller.
- 0.2.11** All products that are packaged to include Pressure vessel(s)/Hydraulic Accumulator(s)/Expansion Vessel(s) are classed as “Assemblies” under the Pressure Equipment Directive (PED). Where units are despatched with “Loose” vessel(s) for assembly on site it is absolutely essential that they be installed as detailed in the instructions using the fittings provided where appropriate. Failure to observe this will nullify compliance with the PED and may present a safety hazard. Your warranty may also be affected.
- 0.2.12** Where Hydraulic Accumulator(s)/Expansion Vessel(s) are supplied as a loose item, they must be installed/connected correctly before operating the equipment, otherwise serious damage from over-pressure/pump overheating could occur.
- 0.2.13** Do not operate this equipment/pumpset prior to commissioning (section 2.2) This could cause irreparable damage to equipment/pumpset/pipework/system components which would not be covered by the warranty.
- 0.2.14** Isolate the equipment/pumpset before pressure testing system. Excess pressure could irreparably damage the pressure transducer, pressure switches (where fitted) and the diaphragms of pressure vessel/hydraulic accumulators.
- 0.2.15** It is the installers’ responsibility to ensure subsequent pipework etc can accept the pressures generated by the equipment/pumpset and to install an overpressure safety device into the system with due respect to the suction pressure present on the pumpset, the pump closed valve pressure stated on the pump, the maximum working pressure stated on any of the attached pressure vessels and any other device connected to the system e.g. boilers, calorifiers etc.
- 0.2.16** When chlorination of the system is carried out, ensure that any residual chlorine is removed by thorough flushing as detailed in the HSE approved code of practice L8, to avoid damaging the equipment/pumpset. The normal level of chlorination is up to 2 parts per million (ppm), but shock dosing for sterilization purposes, at 25-50 ppm for 24-48 hours is acceptable as long as all chlorine is

- removed once the process is complete. Chlorination beyond these limits could seriously damage pumpset components and WILL NOT be covered by the warranty.
- 0.2.17** The installer/user is responsible for the installation of the correct earthing and protection according to valid national and local standards. All operations must be carried out by a suitably qualified person.
- 0.2.18** The equipment is only suitable for earth referenced supplies and must be permanently earthed to avoid electric shock hazard.
- 0.2.19** The equipment must be permanently earthed with appropriate sized Earthing.
- 0.2.20** Equipment containing variable speed drives/motors has high earth leakage current >3.5mA and will require additional earth bonding whereby a single conductor of increased size or duplicate earth conductors must be provided.
- 0.2.21** Never perform high voltage resistance tests on control panels, variable speed drives/motors without first disconnecting the panel/drive/motor from the circuit being tested as this will damage the built in electronic components.
- 0.2.22** Equipment containing variable speed drives/motors that has been stored/not powered up for long periods of time (i.e. 1 year or more) may require the variable speed drive/motor capacitors to be reformed. Please contact AquaTech-Pressmain for more information. Failure to reform capacitors will result in drive/motor damage.
- 0.2.23** Metal parts (e.g. heat sinks) may reach temperatures of 90 degrees centigrade.
- 0.2.24** RCD's/ELCB's are not recommended for use with variable speed drives/motors. Where their use is mandatory use type B RCD's. For single phase sets with inverter motors the earth leakage circuit breaker must trip out when earth fault currents with DC content (pulsating DC) occur. For three phase sets with inverter motors the earth leakage circuit breaker must trip out when earth fault currents with DC content (pulsating DC) and smooth DC earth fault currents occur.
- 0.2.25** RCD's/ELCB's suitable for use with variable speed drives/motors are not suitable for personnel protection.
- 0.2.26** EMC – Grundfos inverter motors 0.37kW to 5.5kW Electromagnetic disturbance – first environment (residential areas) – unrestricted distribution, corresponding to CISPR 11, class B, group 1. Inverter motors > 5.5kW Electromagnetic disturbance – first environment (residential areas) –restricted distribution. Immunity to Electromagnetic disturbance – second environment (industrial areas) – unrestricted distribution, corresponding to CISPR 11, class A, group 1. Inverter motors > 5.5kW for installation in first environment (residential areas) require additional EMC filter to obtain class B, group 1 status.
- 0.2.27** EMC - With respect to BS EN61000-3-2 this equipment is defined as 'professional equipment' and therefore the installer/user may need to seek permission from the supply utility to connect this equipment to the public low voltage mains supply.
- 0.2.28** Where "Expansion vessels" are used on Domestic hot water systems (DHWS) or LTHW heating system pressurisation units, the temperature of the fluid returning to the vessels should not exceed 70 degrees Centigrade as this could damage the vessel diaphragm. Where the temperature exceeds 70C an intermediate cooling vessel should be fitted.
- 0.2.29** Where "Expansion vessels" are used on Domestic hot water systems (DHWS) or LTHW heating system pressurisation units, the glycol content in the water must not exceed 50%.
- 0.2.30** Drain cocks/valves and air bleed screws must not be left open as this could cause flooding.
- 0.2.31** When positioning, the tank MUST be lifted. The tank MUST NOT under any circumstances be dragged. The tank should be lifted using a suitable pallet to the underside and by using a pallet/forklift or crane by passing strops underneath the tank and/or pallet using a spreader bar. Any pallets must be no smaller than the overall external length and width dimensions of the tank. It is essential that no load is placed by pallets, supports, fork lift truck forks or similar, to the unsupported single skin base of any tank. Failure to utilise these correct lifting and/or movement procedures will result in damage to the base of the tank.
- 0.2.32** The tank is not suitable for use as a working platform or designed to support the weight of man traffic. Standing on, walking across, or use of the tank as a support of any kind and for any purpose may result in death or serious injury and/or structural failure of the tank resulting in serious damage to equipment and/or property.
- 0.2.33** Where the fitting of connections to the tank is to be carried out on site it is essential that the operator carrying out such work is fully trained and familiar with carrying out an operation of this type.

- 0.2.34** During the process of on-site fitting of connections, the cutting of the tank body and/or lid may result in the production of GRP dust, swarf, shards and/or splinters. It is essential that any persons carrying out such work are fully protected from these hazards by use of correct Personal protection equipment.
- 0.2.35** During the process of the on-site fitting of connections and/or any other work requiring the use of hand tools or powered tools and/or equipment of any type it is essential that any operator is fully conversant with the correct use of the equipment and is fully protected by the use of the correct personal protection equipment. Always consult tool/equipment manufacturer's users' manuals prior to use.
- 0.2.36** When installing water storage tanks always consult the current water regulations and local water authority regulations and requirements to ensure that the installation of the tank is suitable for the application, correctly carried out and does not contravene such regulations.
- 0.2.37** Any connections, pipework and/or equipment of any kind connected to or in association with the tank must be fully supported by independent brackets and/or similar structures and fixings. It is essential that the tank body and/or lid are NOT used to provide support of any kind for equipment or items of any kind.



0.3 CAUTIONS FOR OPERATION/USER

- 0.3.1** READ GENERAL SAFETY INFORMATION 0.0, WARNINGS 0.1 and CAUTIONS 0.2, 0.3 & 0.4
- 0.3.2** The unit should only be operated/used by a competent person; *A competent person is someone who is technically competent and familiar with safety practices and the hazards involved.*
- 0.3.3** The Owner/User of this equipment has a Legal Responsibility to ensure that it is subject to regular formal inspections. See Section 3. Servicing, for details.
- 0.3.4** Where Hydraulic Accumulator(s)/Expansion Vessel(s) are supplied as a loose item, they must be installed/connected correctly before operating the equipment; otherwise serious damage from over-pressure could occur.
- 0.3.5** The set must not be run until commissioned by an authorised AquaTech-Pressmain agent, this could irreparably damage the pump set and/or system components/pipework connected to it which would not be covered by the warranty.
- 0.3.6** The pumpset should be left switched ON with the pumps switched to AUTO for normal operation.
- 0.3.7** The pumpset should not be left in "Hand" operation for more than 1 minute. This could lead to severe damage of pumpset components and/or pipework system from over-pressure and/or overheating.
- 0.3.8** Ensure pumpset has an adequate water supply at all times to prevent dry running causing pump seal damage and water leakage.
- 0.3.9** Do no attempt to start pumps without liquid in volutes (pumps must be fully primed); mechanical seals must have a film of liquid between faces for proper operation and to prevent damage.
- 0.3.10** Portable telephones or other electro-magnetic equipment must not be used near the set to avoid corruption of program and unpredictable operation of unit.
- 0.3.11** Fire Pump sets: operate regularly (once a week for 1 minute) to prevent seizing
- 0.3.12** After Installation and first filling, the tank should initially be inspected on a weekly basis to ensure that no leaks are present and that no damage or deterioration to the tank structure and associated connections and/or pipework has taken place. After 4 to 6 weeks, provided that no abnormalities have occurred the inspection interval can be increased to 6 months.
- 0.3.13** Any float valves, overflows and/or warning pipes should be inspected on a weekly basis to ensure that the tank is not in an overflow condition. Tanks which are in an overflow condition are a source of considerable waste of water. Water is an expensive and often scarce natural resource; its wastage comprises a threat to the environment and contributes to global climate change.
- 0.3.14** It is a requirement of current water regulations that water storage tanks should be thoroughly inspected at an interval not exceeding one year; in order to determine the state of hygiene inside the tank. If present, any dirt or debris, foreign matter, growths or contamination of any kind should be thoroughly cleaned from the inside of the tank and the tank chlorinated prior to re-commissioning.
- 0.3.15** All screen units which are fitted to any vents, overflows and/or warning pipes should be inspected and if necessary removed, cleaned and re-fitted prior to re-commissioning of the tank.

- 0.3.16** It is essential that tank inspection and cleaning and any other water hygiene work is carried out by the building water hygiene facilities services provider or similar specialist.
- 0.3.17** During any cleaning, and/or chlorination of the tank, only chemicals and materials which are deemed suitable for use in contact with GRP should be used. Chemicals must be at concentrations which will not cause damage to the tank. Contact time for such materials should be no more than 1 hour duration. Any abrasive or aggressive chemical products and/or materials may cause damage to the structure of the tank.



0.4 CAUTIONS FOR MAINTENANCE

- 0.4.1** READ GENERAL SAFETY INFORMATION 0.0, WARNINGS 0.1 and CAUTIONS 0.2, 0.3 & 0.4
- 0.4.2** The unit should only be operated/maintained by a competent person; *A competent person is someone who is technically competent and familiar with safety practices and the hazards involved.*
- 0.4.3** Where the set is fitted with Building Management Services (BMS) interconnections, notify the appropriate persons before switching OFF for maintenance or adjustments, to avoid unnecessary alarm conditions occurring. **WARNING:** With pumpset isolator OFF, mains voltage may still be present from BMS system. This constitutes an Electric shock hazard.
- 0.4.4** To prevent seizing, pumpsets must not be left unused for long periods (e.g. 1 week).
- 0.4.5** The pumps must be run regularly to avoid stagnation of water in the pumps/pipework (e.g. daily).
- 0.4.6** Do not vent air from air valves on vessels. These are for adjustment of pre-set cushion pressures. If wrongly adjusted this will lead to incorrect operation of the pumpset and possible damage to pumps, pipework and system components from overheating and over-pressure.
- 0.4.7** Switch OFF pumpset before accessing pumps and/or control panel.

1. INSTALLATION INSTRUCTIONS

These instructions are intended for the installer of this pressure booster set. Please follow them carefully.

The unit should only be installed by a competent person; *A competent person is someone who is technically competent and familiar with safety practices and the hazards involved.*

Failure to install the equipment as recommended below could invalidate the warranty provided by AquaTech-Pressmain to the purchaser.

1.1 ADDITIONAL WARNINGS

DO NOT TOUCH ANY LIVE PARTS FOR AT LEAST 5 MINUTES AFTER SWITCHING OFF THE POWER. Failure to observe this will constitute an ELECTRIC SHOCK HAZARD.

READ GENERAL SAFETY INFORMATION 0.0, WARNINGS 0.1 and CAUTIONS 0.2, 0.3 & 0.4

1.2 ADDITIONAL CAUTIONS

1.2.1 READ GENERAL SAFETY INFORMATION 0.0, WARNINGS 0.1 and CAUTIONS 0.2, 0.3 & 0.4.

1.2.2 Pumps must be manually primed with water before first operation.

1.3 PROCEDURE

1.3.1 OFF-LOADING AT SITE

Do not lift pumpset by pipework. Lift the pumpset by the container pallet using a pallet/forklift or crane by passing strops underneath the skid using spreader bar.

Failure to utilise these facilities could result in damage.

1.3.2 LOCATION

If the set is to be installed in an unheated room, ensure that there is adequate frost protection.

The location of the equipment should have adequate drainage, bunding or other appropriate measures to protect assets and the building fabric in the event of leakage or water spillage. Failure to provide such measures may result in water damage to property and assets.

Ensure that location for pumpset provides adequate clear space to accommodate unit with reasonable access to all parts; AquaTech-Pressmain recommend a minimum distance of 500mm all round. There must be sufficient room to:-

fully open control panel door;

lift and withdraw pumps;

withdraw diaphragms from vessels.

remove manifolds from pumps.

remove lid from break tank to allow servicing of float valve.

Inspect all sides of the tank,

Check integrity of all tank fittings and clean strainers where fitted,

Inspect tank upstand (where supplied) for rigidity and allow for maintenance,

Any Hydraulic Accumulator supplied should be located as near as possible to the discharge side of the pumpset.

Should any of these location conditions not be satisfied AquaTech-Pressmain reserve the right to charge labour on any warranty work required on the pumpset.

1.3.3 FIXING

Install the set on a flat, even and level surface, where practical on a raised plinth to keep set above damp floor.

Locate unit in position; fit anti-vibration mounts if supplied. If necessary, level the base by inserting packing strips adjacent to bolt positions. Firmly attach pumpset to base.

1.3.4 PIPEWORK

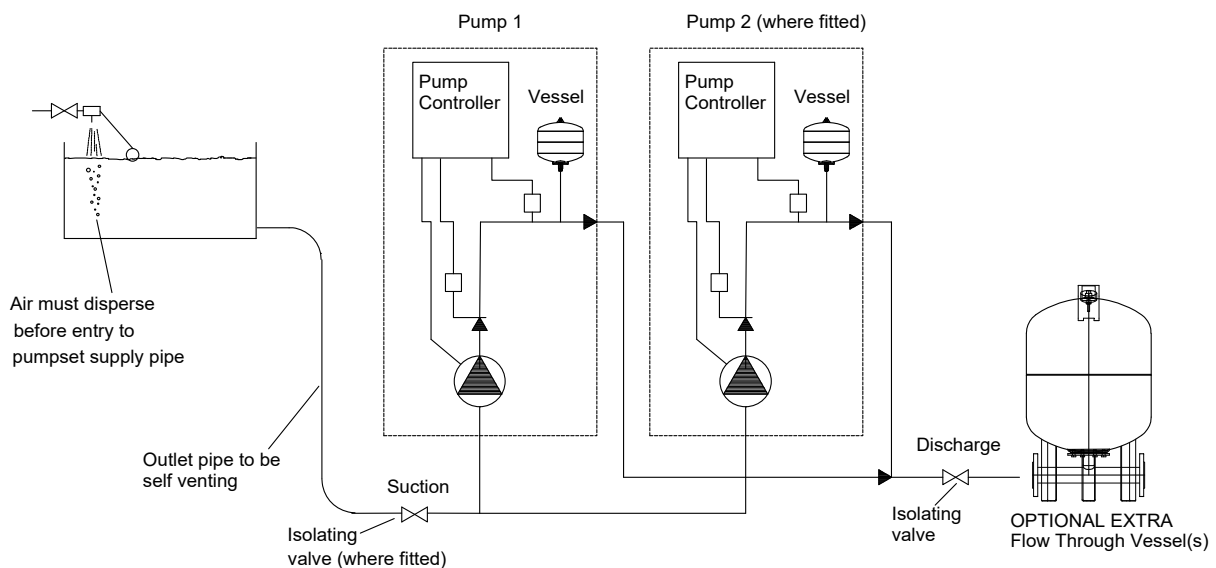

Fig. 1.1 Typical Pipework arrangement

- 1.3.4.1 Arrange mains water breaktank to ensure fully flooded suction conditions to all pumps within the unit,** unless otherwise specified. Minimum requirement = 0.15 bar (1.5 metres)
- 1.3.4.2 Arrange the suction pipework to be self-venting** between the mains water breaktank and the pumpset suction manifold (see fig.1.1).
- 1.3.4.3 Fit isolating valves to the suction side and discharge side of the pumpset** (see fig.1.1), to enable the pumpset to be isolated from the system for maintenance purposes.
- 1.3.4.4 Under no circumstances fit an extra non-return valve,** to either the suction or the discharge, as it may interfere with the correct operation of the non-return valves already fitted as standard in the pumpset.
- 1.3.4.5 Remove any protective end plugs from suction and discharge pipework on pumpset.**
- 1.3.4.6 Connect site pipework to suction and discharge manifolds,** ensuring adequate support is provided to avoid imposing pipe strain on manifolds. The connecting pipework should not be smaller than that of the pumpset. Where flexible pipe connections are fitted, ensure that the correct distance is allowed between flanges, that the pipework is also aligned axially, and no strain is imposed by the site pipework.
- 1.3.4.7 Where Hydraulic Accumulator(s)/Expansion Vessel(s) are supplied as a loose item,** they must be installed/connected correctly before operating the equipment, otherwise serious damage from over-pressure/pump overheating could occur (see also 1.3.5 for correct mounting).
- 1.3.4.8 All hydraulic accumulators and expansion vessels fitted to the system must have isolating and drain off valves** to enable them to be serviced and removable pipework to enable the diaphragm to be replaced.
- 1.3.4.9 Mains water supply:** Connect to $\frac{1}{2}$ " or $\frac{3}{4}$ " inlet valve in tank (as appropriate). Ensure minimum of 1 Bar pressure. Fill the tank. Ensure flow rate into tank equals or exceeds flow rate out of tank/pump.
- 1.3.4.10 If necessary adjust the float to cut off supply just below the warning pipe**

1.3.5 PUMP DETAILS

Pumps are available in 2 sizes, standard and mini, both contain a built in non-return valve, a small hydraulic accumulator vessel and a pump controller.

Pumps must be manually primed with water before first operation.

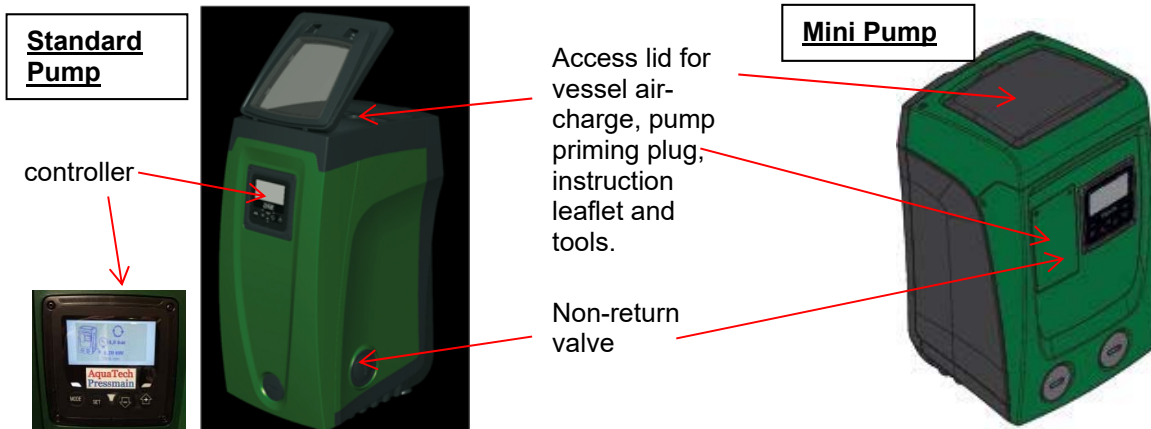

Fig. 1.2 Typical Pump arrangement

1.3.6 FLOW THROUGH VESSELS (when supplied)

12 or 18 litre flow through vessel(s) can be supplied loose for fitting into the discharge pipework via a flowjet isolation and drain valve.

Larger floor standing flow through vessels may be provided as optional extra items fitted on site. Sizes available from 60 litre to 3,000 litre with 1 ¼" up to DN100 connection.



Fig. 1.3 Typical Flow Through Vessels (12l, 300l and 800l shown).

All vessels must be securely mounted to prevent any movement from imposing strain on the attached pipework. Vessels **MUST** be mounted vertically on the integral legs with water connection lowermost.

Set up the vessel so the air charge filling valve (top) and the diaphragm (bottom) are accessible for future maintenance. All vessels must have isolating and drain off valves fitted to enable them to be serviced. The connecting pipework should be removable to give access for replacing the diaphragm and should be the same size as the vessel connection to minimise friction losses. In the case of floor standing vessels, if the system cannot be turned off then supply dual flow through vessels connected in parallel to enable isolation/drainage of one vessel at a time. Contact AquaTech Pressmain for further information.

Set the air cushion pre-charge pressure to the correct level (see section 2.4), dependent on the application required for the vessel. Refer to the Operating parameters at the back of this manual or contact Aquatech-Pressmain for advice.

Caution: If the air cushion pre-charge pressure required exceeds 4.0 Bar then you must follow the procedure shown in section 2.4 to avoid damaging/rupture of the internal diaphragm and consequences of. E.g. High and/or low pressure problems, unstable pump operation.

1.3.7 ELECTRICAL

WARNING: DO NOT TOUCH ANY LIVE PARTS FOR AT LEAST 5 MINUTES AFTER SWITCHING OFF THE POWER TO ALLOW CAPACITORS TO DISCHARGE

READ GENERAL SAFETY INFORMATION 0.0, WARNINGS 0.1 and CAUTIONS 0.2, 0.3 & 0.4

- 1.3.7.1 All wiring must comply with the latest edition of local wiring Regulations.
- 1.3.7.2 **Wear anti-static wrist strap at all times** to avoid static discharge causing problems with the built in electronic program.
- 1.3.7.3 Each pump comes complete with 13 amp 3 pin plug for connection into dedicated 3 pin socket. Connect to electrical mains supply. Ensure voltage and frequency indicated on the motor nameplates and wiring diagrams correspond with supply mains data and that the supply fuse type & rating is correct for the total current rating of the equipment.
- 1.3.7.4 Complete any required earth bonding.

1.3.8 GUIDANCE ON SELECTING THE CORRECT EARTH LEAKAGE PROTECTION DEVICE FOR BOOSTER SETS

All wiring must comply with the latest edition of local wiring Regulations.

Where the incoming electrical supply to the booster set is to be protected by the customer using an Earth Leakage Protection Device, we would recommend that in order to prevent nuisance tripping, follow the information provided below: -

1. Generally, a booster set with pumps/motors that are "variable speed" should have protection that is of the RCCB style, with a 30/100/300mA class "B" RCD part (residual AC/pulsed DC & smooth DC fault currents) which is not of the delayed tripping type. 

If you require any further assistance, please contact AquaTech-Pressmain.

2. USER INSTRUCTIONS

2.1 CUSTOMER ASSURANCE

AQUATECH-PRESSMAIN ASSURE YOU THAT IF ANY PART OF THIS EQUIPMENT BECOMES DEFECTIVE DUE TO FAULTY MANUFACTURE OR MATERIALS WITHIN 12 MONTHS FROM THE DATE OF INVOICE OR 12 MONTHS FROM DATE OF COMMISSIONING BY AUTHORISED AQUATECH-PRESSMAIN AGENT, THE PART WILL BE REPAIRED OR REPLACED.

The only conditions are: -

- ◆ The equipment must have been installed, commissioned, operated and maintained as recommended by **AquaTech-Pressmain**.
- ◆ The equipment must not have been neglected, misused, modified, or used for any other purpose than its original application.
- ◆ The commissioning should be carried out within 6 months of the date of invoice by an authorised **AquaTech-Pressmain** agent.
- ◆ This Assurance does not apply to those items not supplied by us or to defects arising from parts not made or approved by **AquaTech-Pressmain**. The individual manufacturers own policies for dealing with defects will apply.
- ◆ Any part repaired or replaced under these Assurances will be covered for the balance of the appropriate Assurance period.
- ◆ If we have any disagreement about these Assurances which we are unable to resolve we will both abide by the decision of an agreed Arbitrator or, if we are unable to agree, one appointed by the Building and Engineering Services Association (B & ES) Arbitration Scheme Rules.
- ◆ These Assurances are in addition to, and do not detract from, the contractual rights you have under Statute or at common law.
- ◆ Failure to comply with the installation, commissioning and maintenance procedures will invalidate the warranty.

For full details please see the AquaTech-Pressmain "CONDITIONS OF SALE"

2.2 COMMISSIONING

Whilst this set has been tested in the factory to the required settings (detailed in operating parameters at the back of instruction manual), it is impossible to simulate the actual on-site conditions, especially if they are unusual. Also, the settings may have been disturbed since leaving the factory.

Therefore, we strongly recommend **the set is commissioned by our authorised agent** who will prepare the set, make any necessary adjustments and leave the set in operational order.

Commissioning is a requirement to validate the Warranty (see Customer Assurance)

Prior to requesting an engineer to attend the site for commissioning, the client must ensure that;

- the equipment has been correctly installed;
- a written scheme of examination has been obtained where required under the Pressure Systems Safety Regulations;
- any necessary chlorination or other treatment has been completed;
- an adequate water supply and permanent electricity supply are available;
- the pipework etc in the building being served by the pumpset is capable of accepting the generated pressures.

2.3 OPERATING INSTRUCTIONS

These pumpsets are used for increasing the supply pressure of cold potable water and other liquids.

2.3.1 ADDITIONAL WARNINGS

DO NOT TOUCH ANY LIVE PARTS FOR AT LEAST 5 MINUTES AFTER SWITCHING OFF THE POWER

READ GENERAL SAFETY INFORMATION 0.0, WARNINGS 0.1 and CAUTIONS 0.2, 0.3 & 0.4.

2.3.2 ADDITIONAL CAUTIONS

2.3.2.1 READ GENERAL SAFETY INFORMATION 0.0, WARNINGS 0.1 and CAUTIONS 0.2, 0.3 & 0.4.

2.3.2.2 Pumps must be manually primed with water before first operation.

2.3.3 NORMAL OPERATION

The pressure booster set increases and maintains the supply pressure to a preset 'Duty' pressure.

The pumpset consists of one or two (or more) pumps mounted on a baseframe together with associated suction and discharge pipework and valves. The controls are motor mounted.

2.3.3.1 The controller on each pump shows the current pressure and status.



Fig 2.1 Pump Controller

2.3.3.2 For “normal” operation, all pump suction and discharge valves should be left open, all hydraulic accumulator/expansion vessel isolating valves should be left open, and drain cock/valves should be left closed. Should it be necessary to have a situation that is not “normal” operation, then we would strongly recommend



attendance to site by our trained/authorised service personnel. Please contact AquaTech-Pressmain for more details.



2.3.3.3 Pump Controller

The various menus can be accessed using the buttons on the pump controller;

The default settings made by AquaTech Pressmain should be sufficient for most installations. Should the default settings require alteration we would strongly recommend attendance by one of our trained service engineers.

Once in a menu

Press  key to scroll through menu, Press  key to escape menu.

Press  or  to increase or decrease value.

2.3.3.4 "Setpoint Menu" (System pressure adjustment)

To access the Setpoint menu press  &  keys for 2 seconds



SP= Setpoint Pressure
Use "+" and "-" keys to adjust

Fig 2.2 Pump controller display

Adjust the setpoint pressure to the desired value, adjust the pressure vessel air charge to the correct value with respect to the newly programmed setpoint pressure (air charge approx. = setpoint – 1.0Bar).

2.3.3.5 Pump Operation

Intermittent running duty pump with or without one or more optional support pumps meeting demand. Pumps are run at Variable speed.

When demand on the system occurs (e.g. when a tap is turned on) the pressure falls as water from the hydraulic accumulator is discharged into the system. The pump operates at the setpoint pressure and will run for a set period or until the demand is satisfied and the accumulator is replenished. For multi-pump sets; should the pressure continue to fall due to increased demand etc. the support pump(s) will automatically start in sequence and run until the demand is satisfied.

2.3.3.6 Duty Pump Rotation (Multi-pump sets only).

To spread the wear evenly across all the pumps, their sequence is automatically rotated.

2.3.3.7 Automatic Restart

If there is an interruption to the electrical supply the unit will automatically restart on restoration of the supply.

2.3.3.8 Dry Running Protection



The pump(s) is stopped automatically in the event of a low water condition. It will make several attempts to automatically restart when the water supply is restored.

2.3.4 SYSTEM ALARMS

Alarm messages will be displayed on the pump controller.

Some Alarms automatically reset after clearance (PB, OT, BP) or timed intervals (BL, OC) following automatic restart attempts (6 attempts at 10 minute intervals, followed by 24 attempts at 1 hour intervals, followed by 30 attempts at 24 hour intervals).



Alarms can be manually reset by pressing the  and  together. Caution: you can also Enable/Disable the pump by pressing these buttons.

Fault Display	Probable cause	Remedy
BL	<ol style="list-style-type: none"> No water Pump not primed Setpoint not reachable with set RM value 	<ol style="list-style-type: none"> prime pump, remove air in pipe, check suction for blockage. set an RM value that allows setpoint to be reached.
BP1	Faulty pressure sensor	Replace sensor
BP2	Faulty pressure sensor	Replace sensor
OC	<ol style="list-style-type: none"> Motor Over-current Pump seized 	<ol style="list-style-type: none"> Fluid too dense, use only water Remove blockage, free motor shaft.
PB	<ol style="list-style-type: none"> Supply voltage too low Excessive drop in voltage 	<ol style="list-style-type: none"> Check the supply voltage. Check size of cable in supply line
OT	Over temperature of the power stage	Contact service division.
PH	Cutout due to pump overheating	Contact service division.
SC	Short circuit between motor phases	Contact service division.
ESC	Short circuit to earth	Contact service division.
HL	Hot liquid	Contact service division.
NC	Motor disconnected	Contact service division.
Ei	i-th internal error	Contact service division.
Vi	i-th internal voltage out of tolerance	Contact service division.
EY	Abnormal cyclic detected on system	Contact service division.

Table 2.1 System Alarm/fault display

2.3.5 PRIMING/VENTING PUMPS

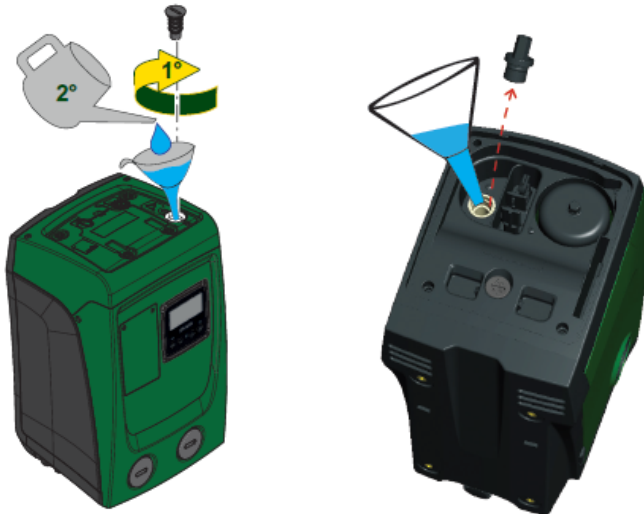

Fig 2.3 Priming/Venting Pumps (mini pump left, standard pump right)

To Prime pumps:

Isolate pumpset from system by closing a common discharge valve.

Switch OFF pump(s)

Remove cover, then remove priming plug and fill with water

Re-tighten plug and refit cover

Switch ON pump(s)

After pump(s) has initialised, **SLOWLY** open discharge valve to bring the pumpset back online. Note: Failure to close the discharge valve, or reopening it too quickly could cause damage to the system.

If a problem persists, contact AQUATECH-PRESSMAIN service department quoting the serial number WN: _____ (on control panel fascia)

2.4 MAINTENANCE INSTRUCTIONS

DO NOT TOUCH ANY LIVE PARTS FOR AT LEAST 5 MINUTES AFTER SWITCHING OFF TO ALLOW CAPACITORS TO DISCHARGE.

2.4.1 ADDITIONAL CAUTIONS

2.4.1.1 READ GENERAL SAFETY INFORMATION 0.0, WARNINGS 0.1 and CAUTIONS 0.2 to 0.4.

2.4.2 PROCEDURE

Every 6 months the pumpset should be maintained by authorised AquaTech-Pressmain service agents - see Servicing (Section 3.)

Expansion, Control and Hydro Accumulator vessels

Air Charge Pressure. The correct charge pressure provides reliable operation of the system and a prolonged lifetime of the diaphragm. This should be checked regularly. As the vessel is small be very careful not to discharge too much air when measuring the pressure!

**LEAVE SET WITH ALL PUMPS SWITCHED ON,
AND THE SYSTEM CONNECTION OPEN**

3. SERVICING

3.1 MAINTENANCE AND CARE OF YOUR EQUIPMENT

The AquaTech-Pressmain equipment that is described in this instruction booklet has been manufactured and tested to the highest standards of design and quality. It will give trouble free operation over many years provided it is maintained regularly from when it is commissioned. To keep it operating efficiently in a safe, economical and environmentally friendly condition, regular maintenance is an essential part.

AquaTech-Pressmain along with its' service division, Acorn Pressurisation Services are the official providers of commissioning and maintenance services. (see below).

Several companies operating under the Aquatronic Group Management structure are available to fulfil a wide range of servicing and maintenance requirements, as detailed below.

3.2 LEGAL REQUIREMENTS

Hydraulic Accumulators/Expansion Vessels installed as part of/in conjunction with this equipment, with Pressure x Volume above 250 Bar-litres, require formal inspection in accordance with a "Written Scheme of Examination". This is a Legal Requirement on the part of the Owner/User under the "Pressure Systems Safety Regulations" (PSSR). A "Written Scheme" and regular inspection can be provided by either Acorn Pressurisation Services (combined maintenance and inspection) or ESIS Ltd (inspection only), see details below.



Plant Servicing & Inspection

ACORN PRESSURISATION SERVICES,

AGM House, Essex, CO6 1GT.

Ph: 01206 215151

10 Wheel Forge Way, Manchester. M17 1EH. Ph: 0161 226 4727

Acorn provides maintenance and installation of all types of packaged water pumping equipment for building services. Its specialist fields are Pressure booster equipment and sealed systems for heating and chilled water distribution systems. Regular servicing of any plant for essential services is vital because wear and tear are very gradual processes. With preventative maintenance, the costs are small and benefits in reliability, safety and economy can be significant. Acorn Pressurisation Services can provide a complete package of schemes for preventative maintenance on all AquaTech-Pressmain and other makes of equipment.



Pressure Vessel Inspection

ESIS ENGINEERING SAFETY & INSPECTION SERVICES LTD,

AGM House, London Rd, Copford, Colchester, Essex, CO6 1GT.

Phone: 01206 215141 Fax: 01206 215142

Under the Pressure Systems Safety Regulations, expansion vessels and hydraulic accumulators, generally 250 bar-litres and greater, and protection devices, require a Written Scheme of Examination before they can be operated. ESIS Inspection and Insurance Services Limited specifications can provide the means to comply with these regulations. These services can be extended to cover other units e.g. air pressure receivers etc.

3.3 SERVICE CONTACTS

For service during warranty period contact: AQUATECH-PRESSMAIN Service Department

Head Office Tel: 01206 215121 Manchester Office Tel: 0161 226 4727

For regular servicing, contact service division: ACORN PRESSURISATION SERVICES

Head Office Tel: 01206 215151 Manchester Office Tel: 0161 226 4727

who will be pleased to give you expert advice on this or any other servicing matter.

4. DISPOSAL

Disposal of this product or parts of it must be carried out in accordance with the following guidelines:

Use the local public or private recycling/waste collection service.

In case such a recycling/waste collection service does not exist or cannot handle the materials used in this product, please deliver the product or any hazardous material from it to your nearest AquaTech-Pressmain office.

EC Declaration of Conformity

We, AquaTech-Pressmain, declare this Assembly:

PRESSURE BOOSTER SET

MODEL: ESL Booster set

Complies with the requirements of EEC Directives:

Low Voltage Directive 2006/95/EC

Electro Magnetic Compatibility Directive 2004/108/EC.



1/3/16

I.D.Taylor, I.Eng. MIET, Director

Aquatronic Group Management Plc
T/A AquaTech-Pressmain

AGM House, London Rd, Copford, Colchester, Essex CO6 1GT UK
Telephone: 01206 215121

OPERATING PARAMETERS

SERIAL No. **MODEL**

THE SERIAL & MODEL NUMBERS MUST BE QUOTED WHEN REQUESTING ASSISTANCE

ELECTRICAL DATA:

Supply 240 volts 1 Ph 50 Hz
 (mini/std pump)
 Maximum current per pump 6A/10A Amps
 Maximum Power per pump 0.8/1.55 Kw Method of starting: Variable speed

NOISE LEVEL: less than 70 db(A) unless otherwise stated

NOMINAL FLOW RATE: litres/sec

PRESSURE SETTINGS:

AS FACTORY SET

bar
 Pump Duty pressure 3.0
 Hyd. Accumulator: 2.0
 Pump closed valve press. 5.5/6.5

❖ AMENDED AT COMMISSIONING	
bar	
.....	
.....	
.....	

❖ On commissioning it may be found necessary to modify these settings. Providing this information is left with the equipment, the figures will be updated by the commissioning engineer.

Updated by commissioning engineer Date