



AquaTech Pressmain

INSTRUCTIONS FOR

0. GENERAL SAFETY INFORMATION, WARNINGS & CAUTIONS
1. INSTALLATION
2. THE USER
3. SERVICING
4. DISPOSAL

TANKMATIC TANK LEVEL/TEMPERATURE MONITORING/CONTROL UNIT WITH SMART RELAY CONTROL

MODELS: MG-L, MG-T, MG-LT.









CE

ISSUE: 5 22/10/09

Head Office: AGM House, London Rd, Copford, Colchester, Essex. CO6 1GT UK
Tel: 01206 215121 Fax: 01206 215131

Manchester Office: Dolphin House, 130 Princess Road, Manchester M16 7BY
Tel: 0161 226 4727 Fax: 0161 226 5848

CONTENTS

	0.0 GENERAL SAFETY INFORMATION		3
0.1	 WARNINGS		3
0.2	 CAUTIONS FOR INSTALLATION		4
0.3	 CAUTIONS FOR OPERATION/USER		6
0.4	 CAUTIONS FOR MAINTENANCE		7
1. INSTALLATION INSTRUCTIONS			8
1.1	GENERAL		8
1.2	ADDITIONAL WARNINGS & CAUTIONS		8
1.3	PROCEDURE		8
1.3.1	SENSORS		8
1.3.1.1	STANDARD SENSORS - EXTERNALLY MOUNTED		8
1.3.1.2	SUBMERSIBLE SENSORS		8
1.3.2	MONITORS AND DISPLAY PANELS		11
1.3.3	ELECTRICAL		11
2. USER INSTRUCTIONS			13
2.1	CUSTOMER ASSURANCE		13
2.2	COMMISSIONING		14
2.3	OPERATING INSTRUCTIONS		14
2.3.1	ADDITIONAL WARNINGS & CAUTIONS		14
2.3.2	NORMAL OPERATION		14
2.3.2.1	LEVEL/TEMPERATURE MONITORING		14
2.3.2.2	TO ACCESS THE STOP/SET PARAMETERS/CLOCK MENU		15
2.3.2.3	TO IDENTIFY THE PROGRAM NAME		15
2.3.2.4	TO STOP/START THE PROGRAM RUNNING		15
2.3.2.5	TO SET OR VIEW THE PARAMETERS		16
2.3.3	SYSTEM ALARMS		17
3. SERVICING			18
3.1	MAINTENANCE AND CARE OF YOUR EQUIPMENT		18
3.2	LEGAL REQUIREMENTS		18

3.3 SERVICE CONTACTS	18
OPERATING PARAMETERS	19
4. DISPOSAL	20
<u>EC DECLARATION OF CONFORMITY</u>.....	20
APPENICIES (WHERE APPLICABLE).....	21



0.0 GENERAL SAFETY INFORMATION



- These instructions are intended for the installer/operator/user/maintenance of this equipment and must be kept with the equipment, for the life of the equipment and made available to all persons. Please read GENERAL SAFETY INFORMATION 0.0, WARNINGS 0.1 and CAUTIONS 0.2, 0.3 & 0.4 before doing anything else, and then follow them carefully.
- The unit must only be installed/operated/used/maintained by a competent person; *A competent person is someone who is technically competent and familiar with safety practices and the hazards involved.*
- Hydraulic Accumulators/Expansion Vessels installed as part of/in conjunction with this equipment, with Pressure x Volume above 250 Bar-litres, require regular formal inspection by a *competent person*. This is a Legal Requirement under the “Pressure Systems Safety Regulations” (PSSR) and the Owner/User should be made aware of their responsibility for this. (see section 3. Servicing).
- Failure to install/operate/use/maintain the equipment as recommended below could cause damage to the equipment any anything subsequently connected to it, and invalidate the warranty provided by AquaTech-Pressmain to the buyer.
- Any damage caused to the equipment by misapplication, mishandling or misuse could lead to risk of **Electrocution, Burns, Fire, Flooding or injury to people or property** dependent upon the circumstances involved.
- This equipment MAY contain moving/rotating parts that must remain guarded. Removal of or missing guards could lead to serious personal injury.
- This equipment automatically restarts after a power interruption.
- We accept no responsibility or liability for any consequences or damage/losses due to misapplication, mishandling or misuse of the equipment.
- It should be noted that the assembly of pressure equipment on site under the responsibility of the user (or his representative) is not subject to the Pressure Equipment Directive 97/23/EC. (National legislation covering assembly on site will apply)
- The latest version of this instruction manual with up to date safety information can be downloaded from our website at www.aquatechpressmain.co.uk

0.1 WARNINGS

- 0.1.1 Do not touch any live parts for at least 5 minutes after switching off the electricity supply. Failure to observe this will constitute a severe Electric shock and/or Burns hazard and may be lethal.**
- 0.1.2 The equipment is only suitable for earth referenced supplies and must be permanently earthed to avoid Electric shock hazard.**

- 0.1.3 With equipment isolator OFF, mains voltage may still be present from BMS system. This constitutes an Electric shock hazard.
- 0.1.4 Emergency stop button does not remove dangerous voltages from control panel/pump motor assemblies. This constitutes an Electric shock hazard.
- 0.1.5 Metal parts (e.g. heat sinks) may reach temperatures of 90 degrees centigrade and will constitute a Burns hazard.
- 0.1.6 Some equipment is designed to operate with liquid temperatures up to 150 degrees centigrade and will constitute a Burns/scalding hazard.
- 0.1.7 The equipment must not be pressurised beyond the maximum working pressure as stated on pressure sensors/temperature sensors/pumps/pipework/vessels/control panel otherwise serious mechanical damage/destruction could occur causing injury to people or property.
- 0.1.8 The equipment must not be heated/chilled beyond the maximum/minimum working temperature as stated on pressure sensors/temperature sensors/pumps/pipework/vessels/control panel otherwise serious mechanical damage/destruction could occur causing injury to people or property.
- 0.1.9 Any damage to equipment, sensors, pumpset, vessels, pipework or system components caused by misapplication, mishandling or misuse could lead to Electric shock hazard, Burns hazard, Fire hazard, Flooding hazard or cause injury to people or property.
- 0.1.10 This equipment may contain moving/rotating parts that must remain guarded. Removal of or missing guards could lead to serious personal injury.
- 0.1.11 Pressure vessels must never be disassembled whilst in use, they contain high pressure air/gas charge which could cause injury to people or property.
- 0.1.12 Pump motors with lifting eyes; the lifting eyes are only suitable for lifting motors NOT the entire pump assembly. This could cause injury to people or property.
- 0.1.13 Ensure the base/foundation/plinth/wall to which the equipment is to be attached is sufficiently strong enough to carry the entire mass of the equipment including the water that it will contain under worst-case fault conditions. E.g. fully saturated pressure vessel with no air charge, break tank full to overflowing, etc. Failure to observe this could cause serious mechanical damage/destruction resulting in injury to people or property.



0.2 CAUTIONS FOR INSTALLATION

- 0.2.1 READ GENERAL SAFETY INFORMATION 0.0, WARNINGS 0.1 and CAUTIONS 0.2, 0.3 & 0.4
- 0.2.2 The unit should only be installed/operated by a competent person; *A competent person is someone who is technically competent and familiar with safety practices and the hazards involved.*
- 0.2.3 Do not lift the pumpset (where supplied) by pipework. Lift the pumpset by the container pallet using a pallet/forklift or crane by passing strops underneath the skid using a spreader bar. Failure to utilise these facilities will result in damage to the pumpset.
- 0.2.4 Store in a dry place to avoid damp conditions deteriorating the equipment.
- 0.2.5 Protect against dirt, damage and frost. It is absolutely essential that no foreign matter such as pipe thread swarf, welding slag, grit or stones are allowed to enter the equipment. Debris of this type can cause severe damage to the sensors, mechanical seals, diaphragms and impeller. Frost/freezing will damage sensors, pumps/pipework and control panel components.
- 0.2.6 The equipment is only suitable for installation in a clean, dust free indoor environment, with adequate protection from heat and frost, and sufficient ventilation to ensure cooling of the motors (where applicable). Ambient air temperature should be between 5 and 40 degrees

centigrade, non-condensating. Operation outside of these conditions could seriously damage the equipment.

- 0.2.7** If the equipment were to be stored or taken out of service for a period of time (e.g. 1 week or more), then we would recommend draining the equipment of all water/liquid (with due regard to any local regulations) to prevent frost damage to components. When restarting is required we would recommend commissioning by our authorised service agent.
- 0.2.8** Ensure the base/foundation/plinth/wall to which the equipment is to be attached has sufficient mass compared to the equipment, in order to avoid noise/vibration transmission. E.g. the mass of the base should be at least five times the mass of the equipment.
- 0.2.9** Ensure the electrical supply is the correct voltage, current, frequency and type for the equipment supplied and that suitable circuit protection equipment is installed in the supply. Incorrect electrical installation could be an electric shock/burns/fire hazard.
- 0.2.10** When accessing the control panel to make electrical connections adopt anti-static procedures e.g. wear anti-static earthed wristband, to avoid risk of damaging the controller.
- 0.2.11** All products that are packaged to include Pressure vessel(s)/Hydraulic Accumulator(s)/Expansion Vessel(s) are classed as "Assemblies" under the Pressure Equipment Directive (PED). Where units are despatched with "Loose" vessel(s) for assembly on site it is absolutely essential that they be installed as detailed in the instructions using the fittings provided where appropriate. Failure to observe this will nullify compliance with the PED and may present a safety hazard. Your warranty may also be affected.
- 0.2.12** Where Hydraulic Accumulator(s)/Expansion Vessel(s) are supplied as a loose item, they must be installed/connected correctly before operating the equipment, otherwise serious damage from over-pressure/pump overheating could occur.
- 0.2.13** Do not operate this equipment/pumpset prior to commissioning (section 2.2) This could cause irreparable damage to sensors/equipment/pumpset/pipework/system components.
- 0.2.14** Isolate the sensors/equipment/pumpset before pressure testing system. Excess pressure could irreparably damage the pressure transducer, pressure switches (where fitted) and the diaphragms of pressure vessel/hydraulic accumulators.
- 0.2.15** Where applicable it is the installers' responsibility to ensure subsequent pipework etc can accept the pressures generated by the equipment/pumpset and to install an overpressure safety device into the system with due respect to the suction pressure present on the pumpset, the pump closed valve pressure stated on the pump, the maximum working pressure stated on any of the attached pressure vessels and any other device connected to the system e.g. boilers, calorifiers etc.
- 0.2.16** When chlorination of the system is carried out, ensure that any residual chlorine is removed by thorough flushing as detailed in the HSE approved code of practice L8, to avoid damaging the sensors/equipment/pumpset. The normal level of chlorination is up to 2 parts per million (ppm), but shock dosing for sterilization purposes, at 25-50 ppm for 24-48 hours is acceptable as long as all chlorine is removed once the process is complete. Chlorination beyond these limits could seriously damage sensors/pumpset components and WILL NOT be covered by the warranty.
- 0.2.17** The installer/user is responsible for the installation of the correct earthing and protection according to valid national and local standards. All operations must be carried out by a suitably qualified person.
- 0.2.18** The equipment is only suitable for earth referenced supplies and must be permanently earthed to avoid electric shock hazard.
- 0.2.19** The equipment must be permanently earthed with appropriate sized Earthing.
- 0.2.20** Equipment containing variable speed drives/motors has high earth leakage current >3.5mA and will require additional earth bonding whereby a single conductor of increased size or duplicate earth conductors must be provided.
- 0.2.21** Never perform high voltage resistance tests on control panels, variable speed drives/motors without first disconnecting the panel/drive/motor from the circuit being tested as this will damage the built in electronic components.
- 0.2.22** Equipment containing variable speed drives/motors that has been stored/not powered up for long periods of time (i.e. 1 year or more) may require the variable speed drive/motor capacitors to be reformed. Please contact AquaTech-Pressmain for more information. Failure to reform capacitors will result in drive/motor damage.

- 0.2.23** Metal parts (e.g. heat sinks) may reach temperatures of 90 degrees centigrade.
- 0.2.24** RCD's/ELCB's are not recommended for use with variable speed drives/motors. Where their use is mandatory use type B RCD's. For single phase sets with inverter motors the earth leakage circuit breaker must trip out when earth fault currents with DC content (pulsating DC) occur. For three phase sets with inverter motors the earth leakage circuit breaker must trip out when earth fault currents with DC content (pulsating DC) and smooth DC earth fault currents occur.
- 0.2.25** RCD's/ELCB's suitable for use with variable speed drives/motors are not suitable for personnel protection.
- 0.2.26** EMC – inverter motors 0.37kW to 5.5kW Electromagnetic disturbance – first environment (residential areas) – unrestricted distribution, corresponding to CISPR 11, class B, group 1. Inverter motors > 5.5kW Electromagnetic disturbance – first environment (residential areas) – restricted distribution. Immunity to Electromagnetic disturbance – second environment (industrial areas) – unrestricted distribution, corresponding to CISPR 11, class A, group 1. Inverter motors > 5.5kW for installation in first environment (residential areas) require additional EMC filter to obtain class B, group 1 status.
- 0.2.27** EMC - With respect to BS EN61000-3-2 this equipment is defined as 'professional equipment' and therefore the installer/user may need to seek permission from the supply utility to connect this equipment to the public low voltage mains supply.
- 0.2.28** Where "Expansion vessels" are used on Domestic hot water systems (DHWS) or LTHW heating system pressurisation units, the temperature of the fluid returning to the vessels should not exceed 70 degrees Centigrade as this could damage the vessel diaphragm. Where the temperature exceeds 70C an intermediate cooling vessel should be fitted.
- 0.2.29** Where applicable Drain cocks/valves and air bleed screws must not be left open as this could cause flooding.



0.3 CAUTIONS FOR OPERATION/USER

- 0.3.1** READ GENERAL SAFETY INFORMATION 0.0, WARNINGS 0.1 and CAUTIONS 0.2, 0.3 & 0.4
- 0.3.2** The unit should only be operated/used by a competent person; *A competent person is someone who is technically competent and familiar with safety practices and the hazards involved.*
- 0.3.3** The Owner/User of this equipment has a Legal Responsibility to ensure that it is subject to regular formal inspections. See Section 3. Servicing, for details.
- 0.3.4** Where Hydraulic Accumulator(s)/Expansion Vessel(s) are supplied as a loose item, they must be installed/connected correctly before operating the equipment, otherwise serious damage from over-pressure could occur.
- 0.3.5** The equipment must not be used/run until commissioned by an authorised AquaTech-Pressmain agent, this could irreparably damage the sensors/pump set and/or system components/pipework connected to it.
- 0.3.6** The controller/pumpset should be left switched ON with the pumps (where fitted) switched to AUTO for normal operation.
- 0.3.7** The pumpset (where appropriate) should not be left in "Hand" operation for more than 1 minute. This could lead to severe damage of pumpset components and/or pipework system from over-pressure and/or overheating.
- 0.3.8** Ensure sensors and pumpset (where appropriate) have an adequate water supply at all times to prevent damage and water leakage.
- 0.3.9** Where appropriate do not attempt to start pumps without liquid in volutes (pumps must be fully primed); mechanical seals must have a film of liquid between faces for proper operation and to prevent damage.
- 0.3.10** Portable telephones or other electro-magnetic equipment must not be used near the set to avoid corruption of program and unpredictable operation of unit.



0.4 CAUTIONS FOR MAINTENANCE

- 0.4.1 READ GENERAL SAFETY INFORMATION 0.0, WARNINGS 0.1 and CAUTIONS 0.2, 0.3 & 0.4
- 0.4.2 The unit should only be operated/maintained by a competent person; *A competent person is someone who is technically competent and familiar with safety practices and the hazards involved.*
- 0.4.3 Where the equipment is fitted with Building Management Services (BMS) interconnections, notify the appropriate persons before switching OFF for maintenance or adjustments, to avoid unnecessary alarm conditions occurring. WARNING: With isolator OFF, mains voltage may still be present from BMS system. This constitutes an Electric shock hazard.
- 0.4.4 Where appropriate; To prevent seizing, pumpsets must not be left unused for long periods (e.g. 1 week).
- 0.4.5 Where appropriate; The pumps must be run regularly to avoid stagnation of water in the pumps/pipework (e.g. daily).
- 0.4.6 Where appropriate; Do not vent air from air valves on vessels. These are for adjustment of pre-set cushion pressures. If wrongly adjusted this will lead to incorrect operation of the pumpset and possible damage to pumps, pipework and system components from overheating and over-pressure.
- 0.4.7 Switch OFF equipment before accessing pumps and/or control panel/sensors etc.

1. INSTALLATION INSTRUCTIONS

FOR TANKMATIC LEVEL/TEMPERATURE MONITORING OR CONTROL UNITS, SERIES MG-L, MG-T, MG-LT with SMART RELAY CONTROL

1.1 GENERAL

These instructions are intended for the installer of this Level/Temperature Monitoring or control unit. Please follow them carefully. Failure to install the equipment as recommended could invalidate the warranty provided by AquaTech-Pressmain Limited to the buyer.

1.2 ADDITIONAL WARNINGS & CAUTIONS

- 1.2.1 READ GENERAL SAFETY INFORMATION 0.0, WARNINGS 0.1 and CAUTIONS 0.2, 0.3 & 0.4
- 1.2.2 Installation of this equipment assumes prior correct and safe installation of the tank(s) and that you are aware of all safety practices and hazards involved with the tank(s).
- 1.2.3 When installing sensors if you are unsure of any aspect you must seek the advice of the tank manufacturer before commencing any modifications/alterations to the tank in order not to compromise its performance.
- 1.2.4 **Level sensors must not be subjected to more than 1.5 times the rating of the sensor;** otherwise irreversible damage may be done.
- 1.2.5 **Temperature sensors must remain submerged at all times.**
- 1.2.6 **When chlorination of a tank is carried out,** ensure that any residual chlorine is removed by thorough flushing as detailed in the HSE approved code of practice L8, to avoid damaging the submersible sensors. The normal level of chlorination is up to 2 parts per million (ppm), but shock dosing for sterilization purposes, at 25-50 ppm for 24-48 hours is acceptable as long as all chlorine is removed once the process is complete.

1.3 PROCEDURE

1.3.1 SENSORS

Sensors are available in **standard** form for attaching externally to the side of the tank, or **submersible** form for suspending in the tank contents.

1.3.1.1 Standard Sensors - externally mounted

Standard Level Sensor for monitoring liquid level:

A standard Level Sensor is fitted to the side of the tank via an isolating valve and 1/4" BSP parallel female connection and wired to wall mounted connection box, or direct to the monitoring unit, within 5m (see Fig 1a.).

The depth of water displayed is that measured from the lowest point of the Level sensor.

Position the sensor at the minimum liquid level.

Standard Temperature Sensor:

A standard Temperature Sensor is fitted to the side of the tank in a 1/2" BSP parallel fitting, or optionally into a sealed pocket (see Fig 1a.) and wired to wall mounted connection box or direct to the monitoring unit, within 5m (see Fig 1a.). Position the Temperature sensor so that it is submerged at all times.

1.3.1.2 Submersible Sensors

Submersible sensors are suspended in the liquid from a connection box on top of the tank as shown in Fig 1b. They are restrained by a weighted guide wire or by a stilling tube to avoid turbulence damaging the sensor.

Drilling the tank lid to take the flange (where supplied) see Fig 2

Select a suitable area of the tank, away from turbulence, for the sensors to be fitted.

Cut 80mm diameter hole taking care to prevent any swarf falling into the tank. Equally spaced about this hole, mark 4 holes as shown in Fig 2, drill and tap M5 or fit clench nuts if required.

Stilling tube where used: Cut the stilling tube to the required length; glue stilling tube to lower flange of connection box or monitor. If adequate height is available do this before mounting the flange on top of tank. Alternatively this could be done from inside an empty tank.

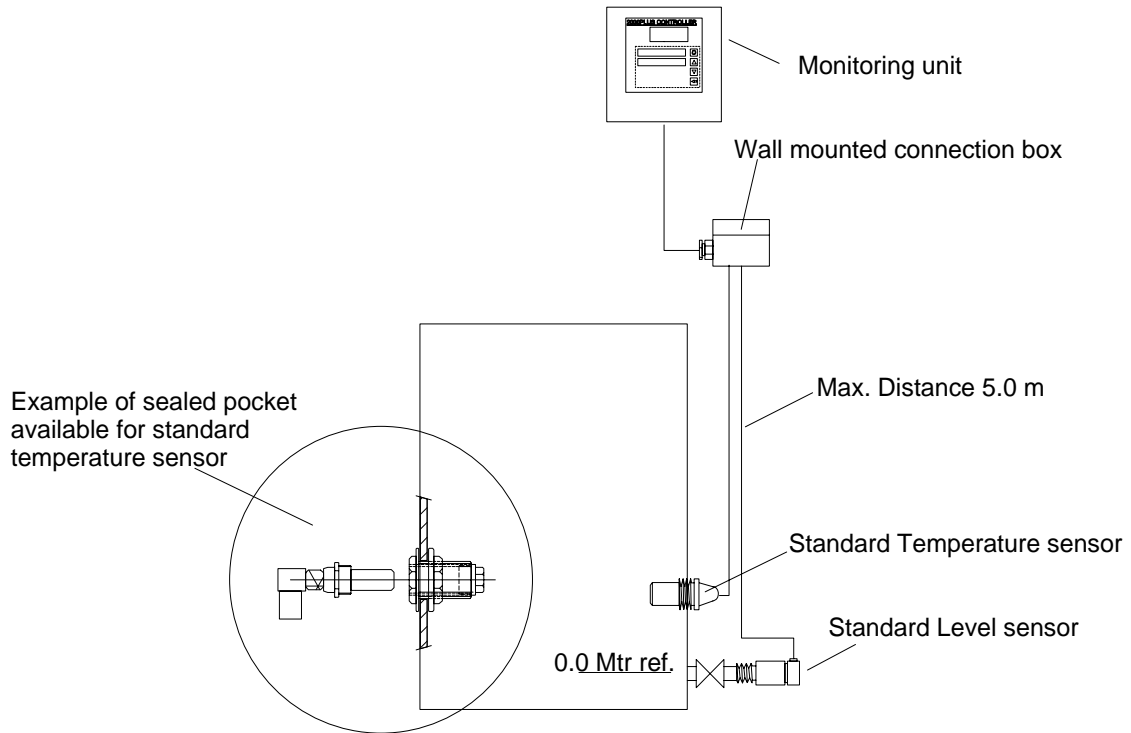

Fig 1a Tank with standard Level and Temperature sensors

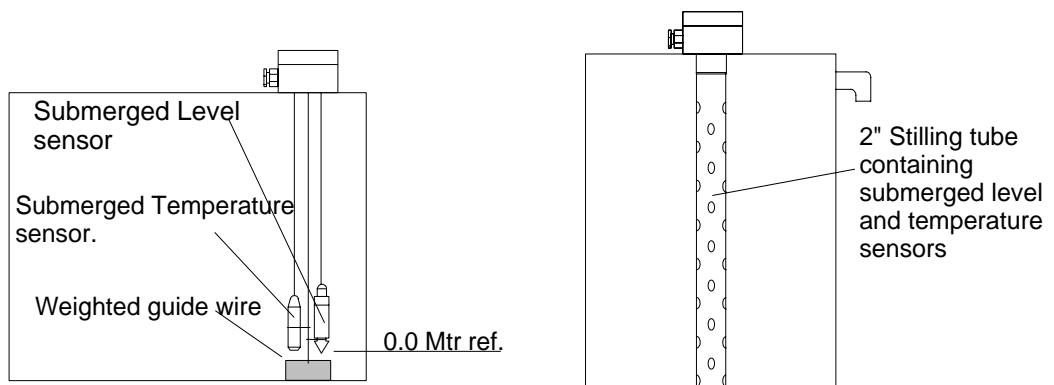
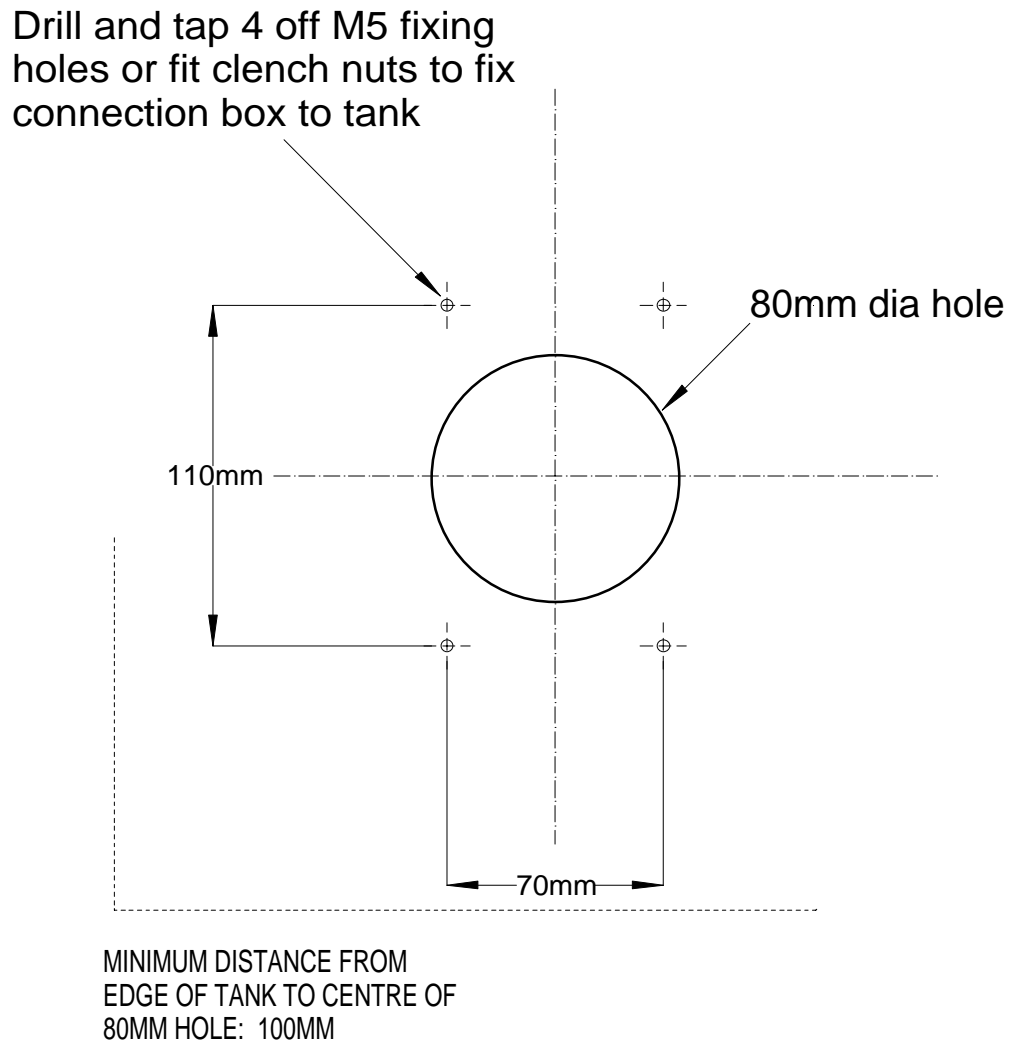

Fig 1b Tank with submersible Level and Temperature sensors

Fig. 2 Drilling detail for fixing a connection box to tank lid.

Fix the lower flange (where supplied) to the tank lid using clench nuts with a sealing gasket between the flange and lid, or glue flange to lid, or use some other suitable method.

Weighted Guide Wire (where used):

Check the sensors are positioned and secured to the guide plate, and the guide plate moves freely on the guide wire.

Placing the sensors in the tank:

If required, sterilise all submersible components (noting 1.2 Cautions).

Pass the Submersible sensor cables, and guide wire where used, through the upper flange glands (on the connecting box) temporarily secure them, adjusting the level of the sensors approximately to the required minimum liquid level of the tank.

To monitor temperature stratification the two Submersible Temperature Sensors are clamped at different levels, one as low as possible, the other as high as possible whilst remaining submerged at all times.

The Submersible Level Sensor cable contains a steel strain wire and plastic vent tube to maintain atmospheric pressure at the sensing head; therefore tight bends in the cable must be avoided. The cable can be cut to suit the tank depth.

Lower the connecting box and Submersible sensors through the tank lid, and seal in place.

Clamp the weighted guide wire, if used, so that the weight is resting on the bottom of the tank and the wire is taut. Secure the end of the wire from passing back through the clamp and remove surplus wire.

Take up any slack in the Sensors and clamp in position with the glands provided.

1.3.2 MONITORS AND DISPLAY PANELS

Monitoring units are mounted on a wall suitable for connection to the sensors. (see note 1.3.3.6)

Remote display units are wall mounted where required.

1.3.3 ELECTRICAL

- 1.3.3.1 READ GENERAL SAFETY INFORMATION 0.0, WARNINGS 0.1 and CAUTIONS 0.2, 0.3 & 0.4
- 1.3.3.2 All wiring must comply with the latest edition of local wiring regulations.
- 1.3.3.3 **Wear anti-static wrist strap at all times** to avoid static discharge causing problems with the built in electronic program.
- 1.3.3.4 For Tankmatic Panels that do not include pumps: Protection for the mains supply line to the unit - Recommended circuit breaker 16Amp Type B or 10 Amp Type C.
- 1.3.3.5 Connect incoming electrical mains supply to identified terminals in the monitoring unit (see Fig 3a or wiring diagram supplied). Ensure voltages and frequency indicated are correct and wiring diagrams correspond with supply mains data and that the supply fuse ratings are correct for the total current rating of the equipment provided.
- 1.3.3.6 Connect Sensors to monitoring unit terminals, via a connection box when provided. (see Fig.3b or wiring diagram)
- 1.3.3.7 For wiring between sensors, monitoring units, connection boxes, and remote display units use 0.75mm² minimum CSA with screen, e.g."CY" cable, earthed at panel end only. Screen earth should ideally be 360 degree termination to steel enclosure or alternatively to earth stud. Any unused cores must be earthed at panel end only. An alternative to screened cable is to use individual cores in EXCLUSIVE steel conduit.
- 1.3.3.8 Where remote signals are required connect terminals in monitoring unit to remote display panel, heeding note 1.3.3.7 (see wiring diagram provided)
- 1.3.3.9 Complete any required earth bonding.

Fig. 3a & 3b Examples of wiring connections inside Control Panel (see wiring diagram provided with unit for full details)

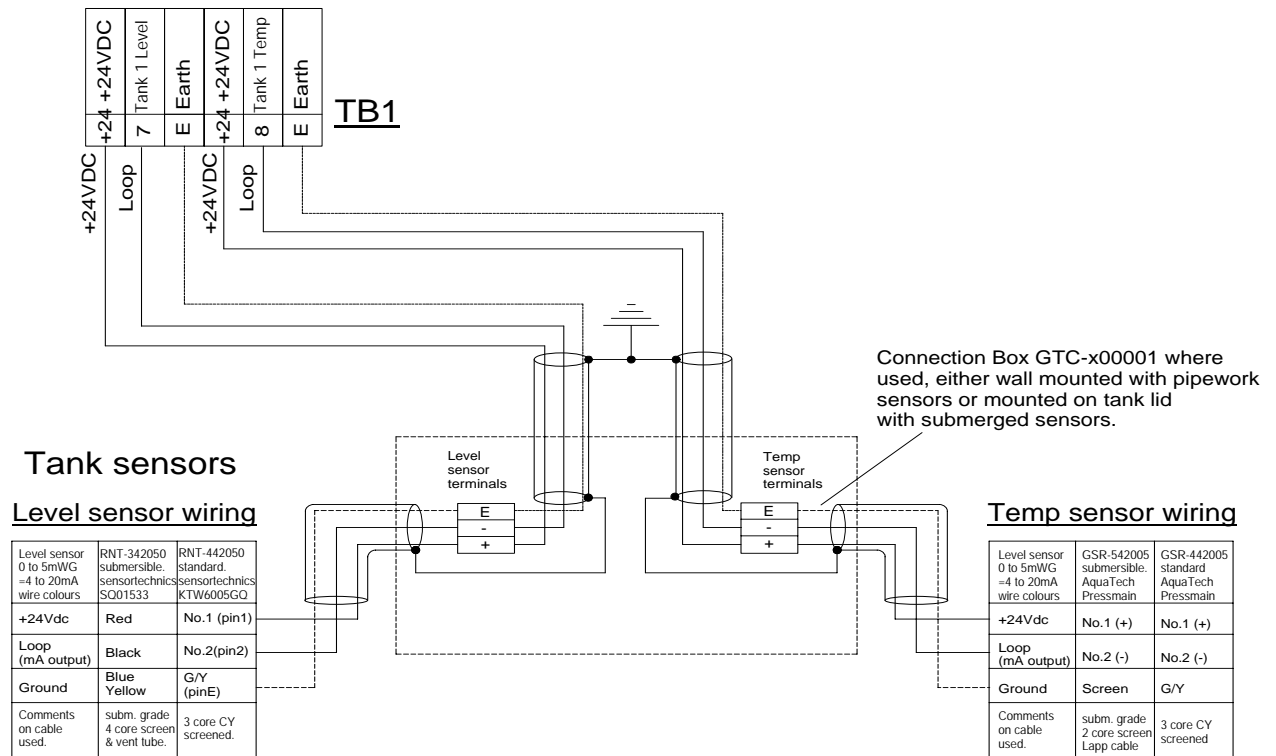
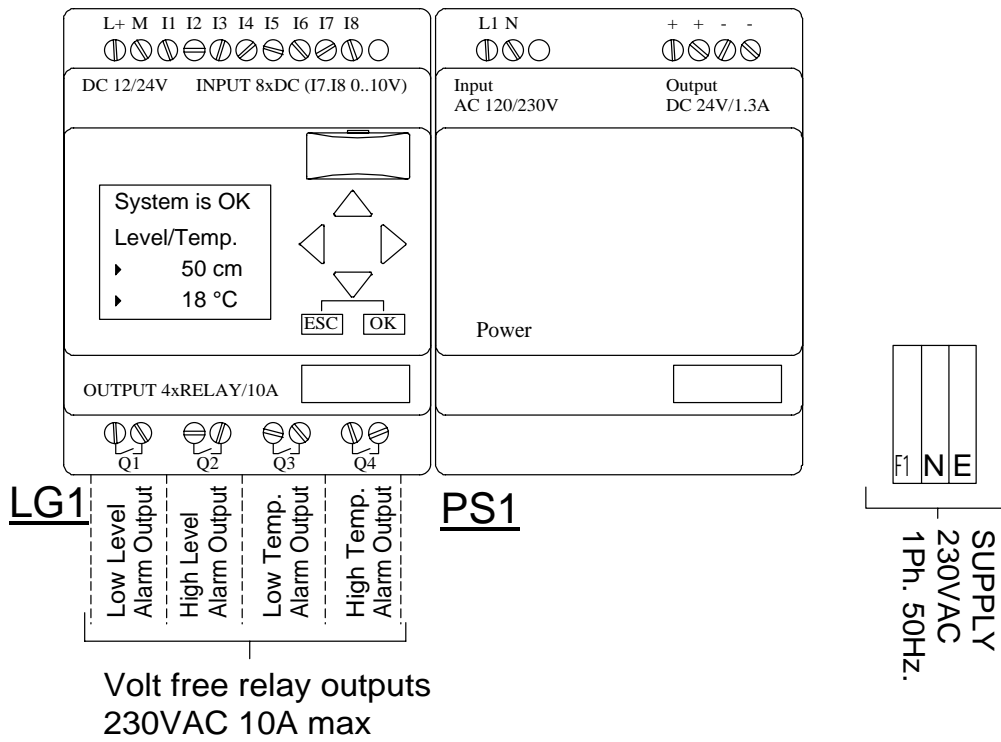

2. USER INSTRUCTIONS

2.1 CUSTOMER ASSURANCE

AQUATECH-PRESSMAIN ASSURE YOU THAT IF ANY PART OF THIS EQUIPMENT BECOMES DEFECTIVE DUE TO FAULTY MANUFACTURE OR MATERIALS WITHIN 12 MONTHS FROM THE DATE OF INVOICE OR 12 MONTHS FROM DATE OF COMMISSIONING BY AUTHORISED AQUATECH-PRESSMAIN AGENT, THE PART WILL BE REPAIRED OR REPLACED.

The only conditions are: -

- ◆ The equipment must have been installed, operated and maintained as recommended by **AquaTech-Pressmain Limited**.
- ◆ The equipment must not have been neglected, misused, modified, or used for any other purpose than its original application.
- ◆ The commissioning should be carried out within 6 months of the date of invoice by an authorised **AquaTech-Pressmain Limited** agent.
- ◆ This Assurance does not apply to those items not supplied by us or to defects arising from parts not made or approved by **AquaTech-Pressmain Limited**. The individual manufacturers own policies for dealing with defects will apply.
- ◆ Any part repaired or replaced under these Assurances will be covered for the balance of the appropriate Assurance period.
- ◆ If we have any disagreement about these Assurances which we are unable to resolve we will both abide by the decision of an agreed Arbitrator or, if we are unable to agree, one appointed by the Heating and Ventilating Contractors Association (HVCA) Arbitration Scheme Rules.
- ◆ These Assurances are in addition to, and do not detract from, the contractual rights you have under Statute or at common law.

For full details please see the AquaTech-Pressmain Ltd. "CONDITIONS OF SALE"

2.2 COMMISSIONING

Whilst this equipment has been tested in the factory to the required settings (detailed in operating parameters at the back of instruction manual), it is impossible to simulate the actual on-site conditions, especially if they are unusual. Also, the settings may have been disturbed since leaving the factory.

Therefore we strongly recommend **the equipment is commissioned by our authorised agent** who will prepare the equipment, make any necessary adjustments and leave it in operational order.

Commissioning also enhances the Warranty (see Customer Assurance)

Prior to requesting an engineer to attend the site for commissioning, the client must ensure that;

- the equipment has been correctly installed including completion of wiring all sensors and remote display panels etc;
- any necessary chlorination or other treatment has been completed;
- an adequate water supply and permanent electricity supply are available.

2.3 OPERATING INSTRUCTIONS

FOR TANKMATIC LEVEL/TEMPERATURE MONITORING AND CONTROL SERIES MG-L, MG-T AND MG-LT with SMART RELAY CONTROL

This equipment is for monitoring and/or controlling the liquid level and/or temperature, in up to 2 storage tanks.

These instructions relate to standard AquaTech-Pressmain equipment and do not necessarily contain details of all possible variations/modifications and custom built variants requested by our customers. The level and/or temperature are displayed on a 4-line LCD display mounted inside the control panel, viewable through a clear Perspex lid. Individual alarm conditions for example, high and low level and/or high and low temperature can be set and displayed on the LCD display. Relay outputs are provided for connection to BMS systems for remote monitoring of tank conditions as specified during quotation. Other features (e.g. audible alarm, tank "normal" condition, solenoid valve actuation signal, pump start/stop, 7 day 24 hour timed operations, etc) can be programmed at time of order. See appropriate equipment specification and/or wiring diagram provided for features of the equipment supplied.

The model number "MG1-" represents 1 tank; "MG2-" represents 2 tanks
 "-L" represents Level monitoring; "-T" represents Temperature monitoring
 "-LT" represents Level and Temperature monitoring

2.3.1 ADDITIONAL WARNINGS & CAUTIONS

- 2.3.1.1 READ GENERAL SAFETY INFORMATION 0.0, WARNINGS 0.1 and CAUTIONS 0.2, 0.3 & 0.4
- 2.3.1.2 Portable telephones or other electro-magnetic equipment must not be used near the equipment whilst running
- 2.3.1.3 MAINS VOLTAGES may be present in the control panel from a BMS system.

2.3.2 NORMAL OPERATION

2.3.2.1 Level/Temperature Monitoring

This unit is controlled by a Tankmatic SMART RELAY controller, which displays the depth of water above the Level sensor to a resolution of 1cm. and where temperature sensors are fitted, the temperature of the water in degrees C is displayed within a given tank.

When switched on, the display shows an alarm free condition like this >
(screens shown are examples only, and may vary depending on unit type)

System is OK
Level/Temp
>40 cm
>18 °C

Or, if an alarm condition is present upon switching on the unit, the display will read whichever alarm is present, similar to this > (the system alarm displays are explained later in this manual)

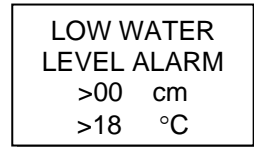

2.3.2.2 To access the stop/set parameters/clock menu

to access the stop/set parameters/clock menu etc, press the <ESC> key and <up arrow> key at the same time

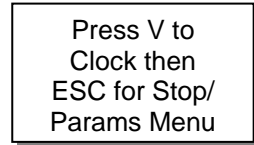

Or,

press the <down arrow> repeatedly ,(this scrolls through any fault messages) until the clock is displayed.

Note: to get to the clock, it may require pressing <left> or <right> arrows if Inputs, Outputs, Markers or Cursor are displayed!

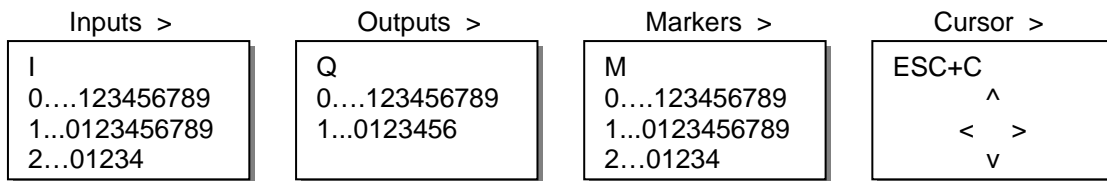
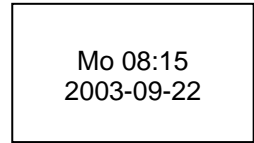

When the clock is displayed press <ESC> key. The stop/set parameters/clock Menu is now displayed. **Note:** if the clock is not set then it will flash. The time/date is retained for approximately 80 hours during power down.

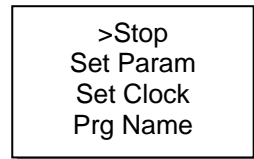

2.3.2.3 To identify the Program Name

to identify the program name, access the stop/set parameters/clock menu as above, then press the <down arrow> until the cursor points to ">Prg Name"

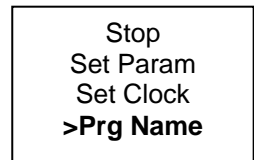

then press the <OK> key to display program name. Press <ESC> repeatedly until the clock is again displayed, followed by the <up arrow> to return to the main system screen.

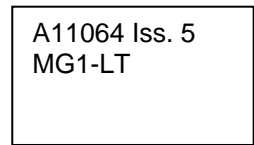

2.3.2.4 To Stop/Start the Program Running

to stop/start the program running, access the stop/set parameters/clock menu as above, then press the <down arrow> until the cursor points to ">Stop"

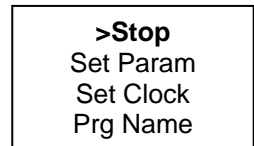

Then press <OK> and select "Stop Prg" >Yes <OK>.

to start program press the <down arrow> repeatedly until the cursor points to ">Start". Then press <OK>

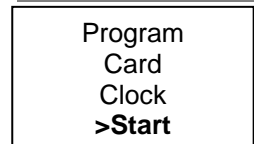

2.3.2.5 To set or view the parameters

to set or view the parameters, access the stop/set parameters/clock menu as above, then press the <down arrow> until the cursor points to ">Set Param"

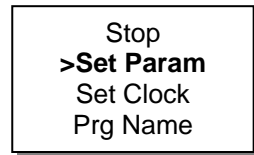

Please note: The screens shown on the unit are dependent on the unit type, i.e. 1 or 2 tanks, Level and/or Temperature etc.

then press the <OK> key to display parameter name. Press <up arrow> to display the next parameter or <OK> to set the parameter.

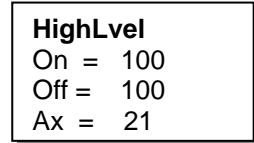

e.g. to SET the High Level Alarm parameter, press the <OK> key to display parameter values. Press <left/right arrow> to select the digit to alter, followed by the <up/down arrow> to alter value. Press <OK> to set the parameter.

Important Note: the values MUST remain "+" do not set them to "-".

The ON / OFF parameters **Must** be set to the **same value.** Ignore Ax.

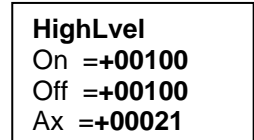

Press <up arrow> to display the Low Level Alarm parameter, The ON / OFF parameters must be set to the same value. Ignore Ax.

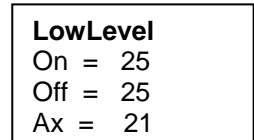

Press <up arrow> to display the High Temperature Alarm parameter, The ON / OFF parameters must be set to the same value. Ignore Ax.

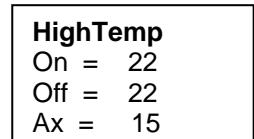

Press <up arrow> to display the Low Temperature Alarm parameter, The ON / OFF parameters must be set to the same value. Ignore Ax.

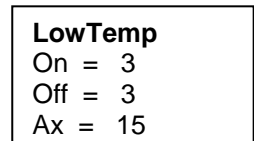

Press <up arrow> to display the Output Invert parameter. This is where the Low and High water level/Temperature alarm volt free relays can be set as Normally Open (N/O) or Normally Closed (N/C). The default setting is Normally Open (N/O), which closes to a fault condition.

If the Low and High water level/Temperature volt frees need to be changed to Normally Closed, simply change the Outptlnv switch to "ON".

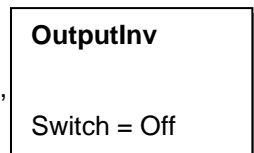

Note: Other unit types may have different parameters, such as Low level approach, High level approach etc, but would be set in the same way. Refer to the wiring diagram provided with the unit for the actual volt free outputs/parameters supplied.

Once the parameters have been adjusted to suit the site conditions, press <ESC> until the clock is Displayed, followed by the <up arrow> to return to the main system screen.

2.3.3 SYSTEM ALARMS

Display giving type of fault and volt-free output signal (where fitted) and audible alarm (where fitted).

Automatic reset of alarms is provided

Note: fault messages are scrolled through automatically.

If more than 1 fault message is activated then all messages will be scrolled through.

SYSTEM ALARM Info Follows > 30cm > 0°C

LOW WATER TEMPERATURE > 30cm > 0°C
--

Please note: The alarm screens shown on the unit are dependent on the unit type, i.e. 1 or 2 tanks, Level and/or Temperature etc.

** System Alarm Message **	Cause	Check
LOW WATER LEVEL/LOW LEVEL APPROACH	Tank level at/below low water level/low level approach setting	Float valve sticking closed. Incoming water supply interrupted or insufficient to keep up with outgoing demand.
HIGH WATER LEVEL/HIGH LEVEL APPROACH	Tank level at/above high water level/high level approach setting	Float valve sticking open. Outgoing supply flow reversed back into tank.
LOW WATER TEMPERATURE	Tank water temperature at/below low water temperature level	Ambient temperature too low. Insufficient frost protection.
HIGH WATER TEMPERATURE	Tank water temperature at/above high water temperature level	Ambient temperature too high. Tank heaters set too high. Constant running pump causing increase in water temperature circulating back into tank.
RELAY OUTPUT DISABLED	Enable/Disable relay outputs switch set to "Disable"	Usually set to disable relay outputs during tank cleaning to prevent false alarms on BMS.
NO WATER IN BREAKTANK	Where supplied the Low level float switch in tank has activated.	Float valve sticking closed. Incoming water supply interrupted or insufficient to keep up with outgoing demand.
PLEASE NOTE: BUZZER MUTED	Where fitted, the mute audible alarm button has been pressed.	Automatically resets when alarm is no longer present.
SERVICE DUE TEL: AQUATECH-PRESSMAIN	12 month service timer elapsed	Phone Aquatech-Pressmain to arrange annual service visit.

If a problem persists, contact AQUATECH-PRESSMAIN service department quoting the serial number WN: _____ (on control panel fascia)

3. SERVICING

3.1 MAINTENANCE AND CARE OF YOUR EQUIPMENT

The AquaTech-Pressmain equipment that is described in this instruction booklet has been manufactured and tested to the highest standards of design and quality. It will give trouble free operation over many years provided it is maintained regularly from when it is commissioned. To keep it operating efficiently in a safe, economical and environmentally friendly condition, regular maintenance is an essential part.

AquaTech-Pressmain Limited along with its' sister company, and fellow AGM Group member, Acorn Pressurisation Services Ltd are the official providers of commissioning and maintenance services. (see below).

Several companies operating under the Aquatronic Group Management structure are available to fulfil a wide range of servicing and maintenance requirements, as detailed below.

3.2 LEGAL REQUIREMENTS

Hydraulic Accumulators/Expansion Vessels installed as part of/in conjunction with this equipment, with Pressure x Volume above 250 Bar-litres, require formal inspection in accordance with a "Written Scheme of Examination". This is a Legal Requirement on the part of the Owner/User under the "Pressure Systems Safety Regulations" (PSSR). A "Written Scheme" and regular inspection can be provided by either Acorn Pressurisation Services (combined maintenance and inspection) or ESIS Ltd (inspection only), see details below.

Plant Servicing & Inspection



ACORN PRESSURISATION SERVICES LIMITED,
AGM House, Essex, CO6 1GT. Ph: 01206 215151
130 Princess Rd, Manchester, M16 7BY. 0161 226 4727

Acorn provides maintenance and installation of all types of packaged water pumping equipment for building services. Its specialist fields are Pressure booster equipment and sealed systems for heating and chilled water distribution systems.

Regular servicing of any plant for essential services is vital because wear and tear are very gradual processes. With preventative maintenance, the costs are small and benefits in reliability, safety and economy can be significant. Acorn Pressurisation Services Ltd can provide a complete package of schemes for preventative maintenance on all AquaTech-Pressmain and other makes of equipment.

Pressure Vessel Inspection



ESIS ENGINEERING SAFETY & INSPECTION SERVICES LTD,
AGM House, London Rd, Copford, Colchester, Essex, CO6 1GT.
Phone: 01206 215141 Fax: 01206 215142

Under the Pressure Systems Safety Regulations, expansion vessels and hydraulic accumulators, generally 250 bar-litres and greater, and protection devices, require a Written Scheme of Examination before they can be operated. ESIS Inspection and Insurance Services Limited specifications can provide the means to comply with these regulations. These services can be extended to cover other units e.g. air pressure receivers etc.

Pump Repairs and Overhauls



AGM PUMP SERVICES LIMITED,
AGM House, London Rd., Copford, Colchester, Essex CO6 1GT
Phone: 01206 215111 Fax: 01206 215112

AGM Pump Services Limited can provide a full range of overhaul and replacement facilities for pumps on both AquaTech-Pressmain and other makes of equipment. Drawing on extensive expertise, it can carry out the full overhaul of pumps, including the removal and refitting of the pumps to site using its skilled technicians. It can also provide a full workshop investigation of any given pump.

3.3 SERVICE CONTACTS

For service during warranty period contact: AQUATECH-PRESSMAIN Service Department
Head Office Tel: 01206 215121 Manchester Office Tel: 0161 226 4727

For regular servicing, contact their service agents: ACORN PRESSURISATION SERVICES LTD
Head Office Tel: 01206 215151 Manchester Office Tel: 0161 226 4727

who will be pleased to give you expert advice on this or any other servicing matter.

Notes....

OPERATING PARAMETERS

SERIAL No. **MODEL**.....

THE SERIAL & MODEL NUMBERS MUST BE QUOTED WHEN REQUESTING ASSISTANCE

ELECTRICAL DATA:

Supply volts Ph Hz
 Full load current of unit Amps
 Max. unit loading: Kw
 Control Voltage 24 volts DC

PARAMETERS as factory set

PARAMETER	Tank 1	Tank 2	Tank 3	Tank 4
Low level ON/OFF				
Low level approach ON/OFF				
High level ON/OFF				
High level approach ON/OFF				
Low temperature ON/OFF				
High temperature ON/OFF				

as amended on commissioning

Tank 1	Tank 2	Tank 3	Tank 4

Important note: For each parameter, the ON/OFF parameters MUST be set to the same value.

Some of the above parameters may not be seen, depending on unit type.

On commissioning it may be found necessary to modify these settings. Providing this information is left with the equipment, the commissioning engineer will update the figures.

Updated by commissioning engineer Date

4. DISPOSAL

Disposal of this product or parts of it must be carried out in accordance with the following guidelines:

- 4.1 Use the local public or private recycling/waste collection service.
- 4.2 In case such a recycling/waste collection service does not exist or cannot handle the materials used in this product, please deliver the product or any hazardous material from it to your nearest AquaTech-Pressmain office.

EC Declaration of Conformity

We, Aquatech-Pressmain Limited, declare this
TANKMATIC LEVEL/TEMPERATURE MONITORING/CONTROL UNIT
 MODELS: MG-L, MG-T, MG-LT.

when installed and used in accordance with the instruction manual provided is in conformity with the following standards:
BS EN 60204-1:2006, BS 61000-6-1:2001, BS 61000-6-3:2001
 following provisions of EEC Directives:
Low Voltage Directive 73/23/EEC and 93/68/EEC,
Electro Magnetic Compatability Directive 89/336/EEC with amendments 92/31/EEC.

 26.08.04
 I.D.Taylor, I.Eng.MIET. Director, **AquaTech-Pressmain Limited.**
 AGM House, London Rd, Copford, Colchester, Essex CO6 1GT UK
 Telephone: 01206 215121 Facsimile: 01206 215131